



BOSCH

Climate 6000iP

CL6000iP W 26 | CL6000iP W 26 F | CL6000iP W 35 | CL6000iP W 35 F |
CL6000iP 26 | CL6000iP 35 |

bg	2
cs	5
da	8
de	11
el	14
en	17
es	20
et	23
fi	26
fr	29
hr	32
hu	35
it	38
lt	41

lv	44
mk	47
nl	50
pl	53
pt	56
ro	59
sk	62
sl	65
sq	68
sr	71
sv	74
tr	77
uk	81

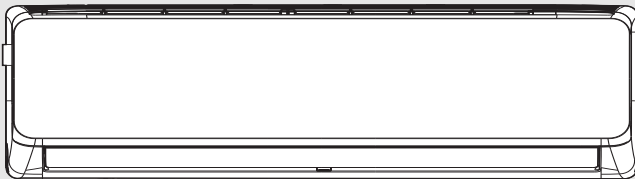

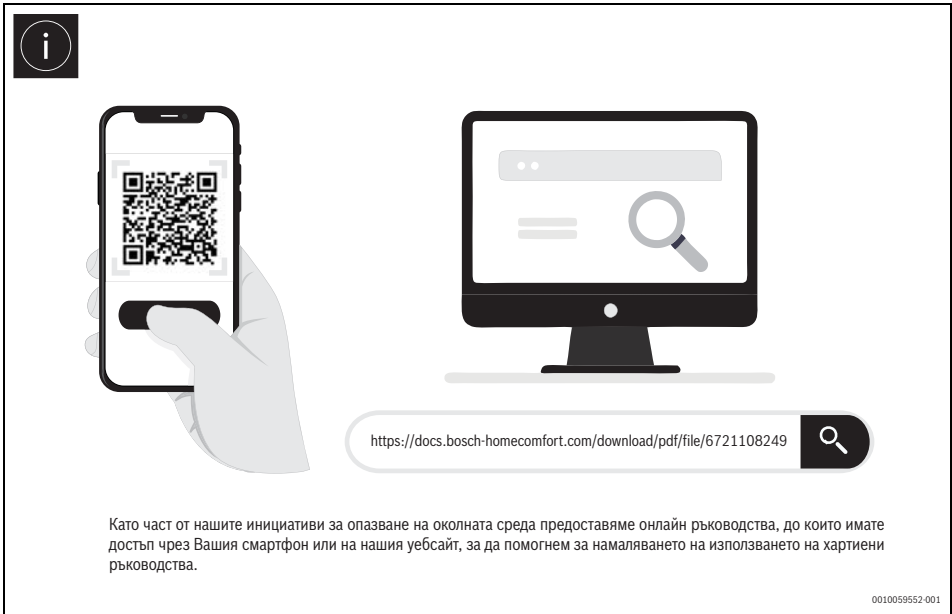

Фиг. 1

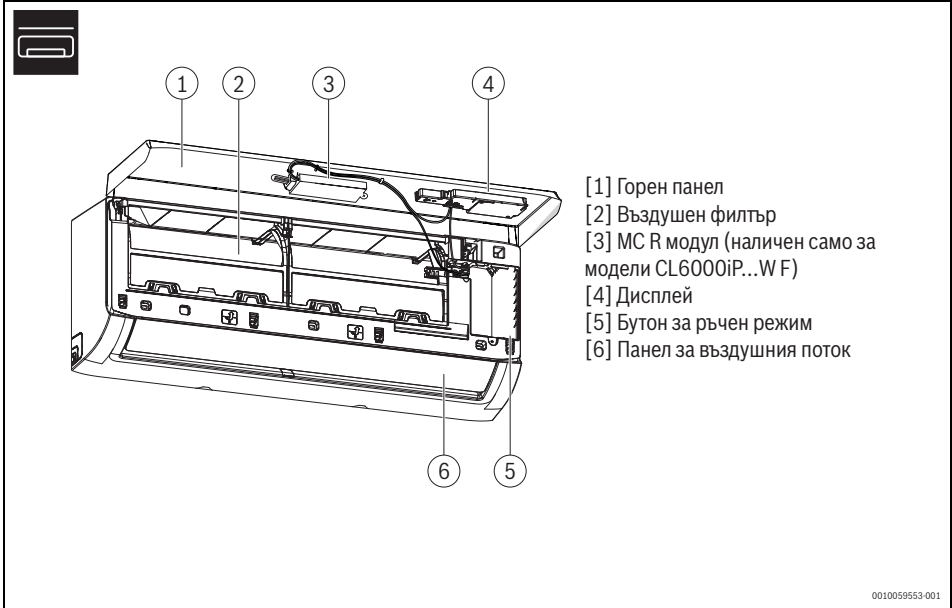

Фиг. 2



Фиг. 3

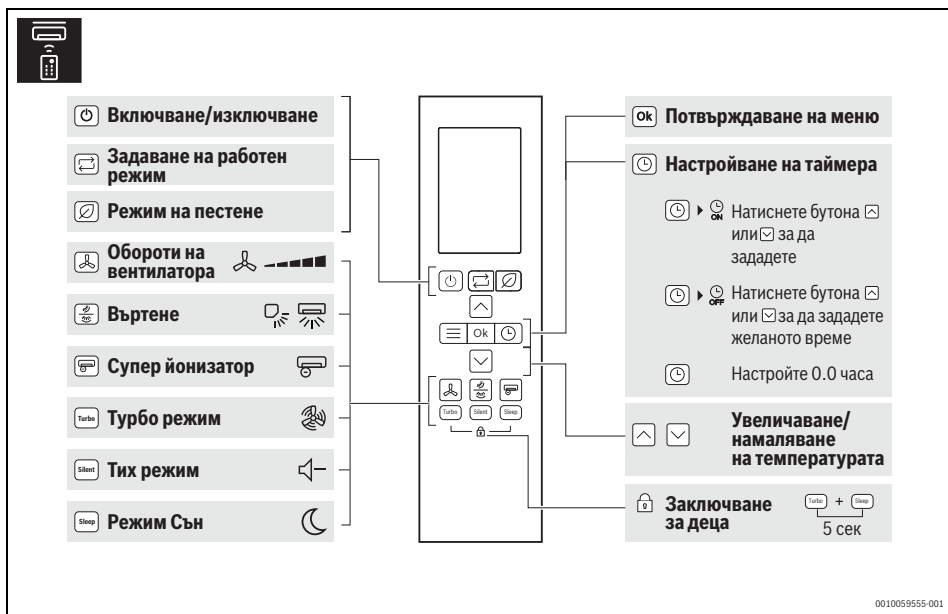

Фиг. 4

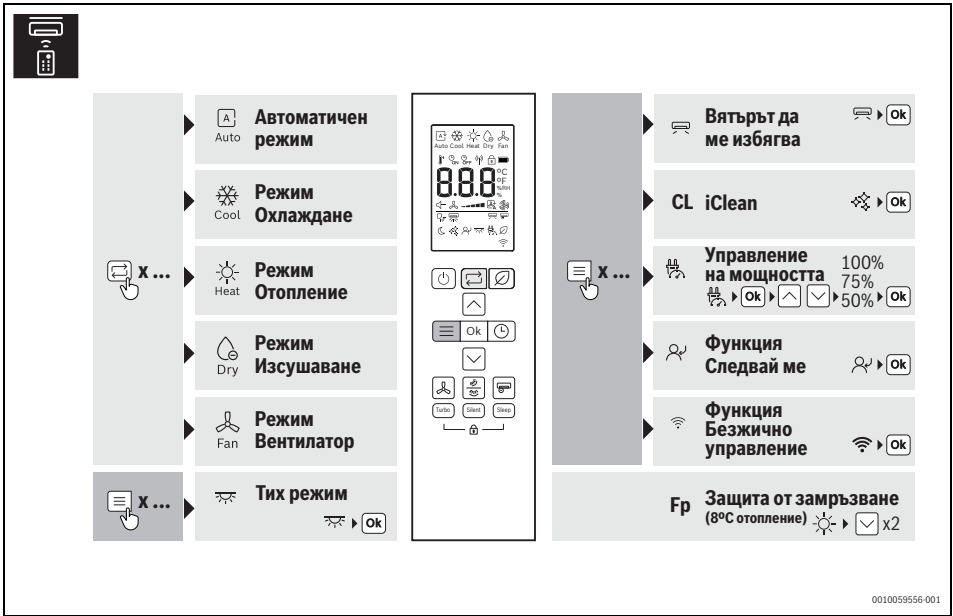

Фиг. 5

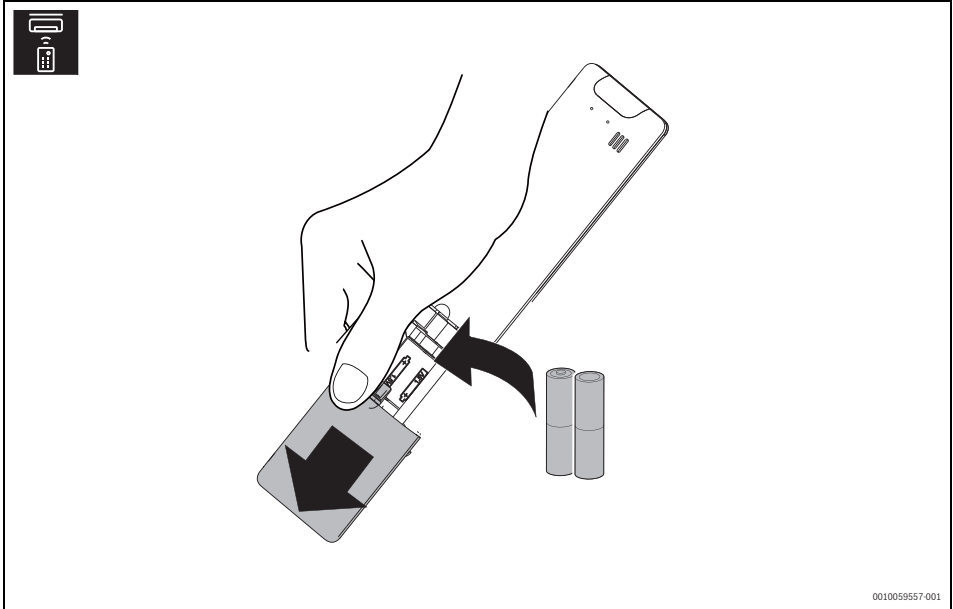

Фиг. 6

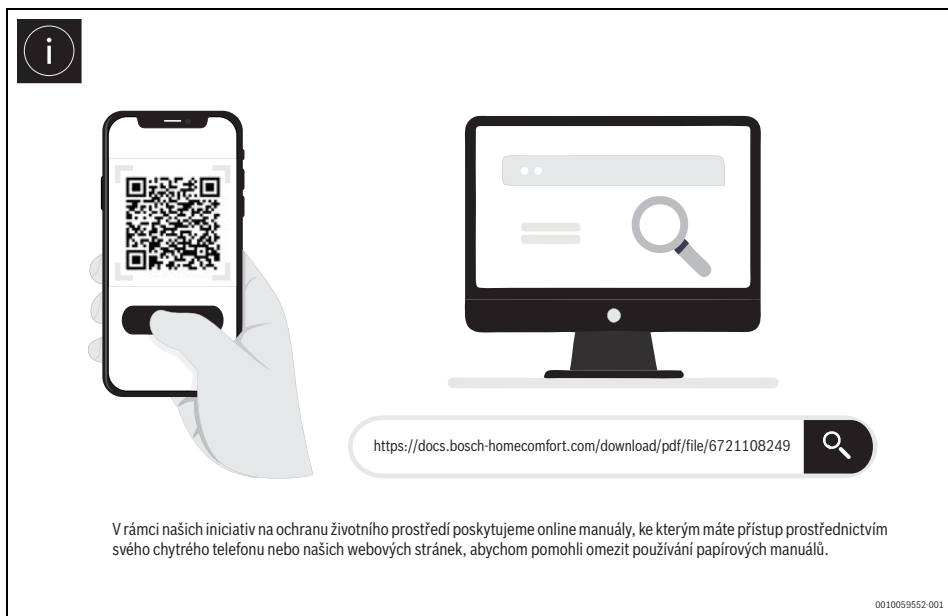

Obr. 7

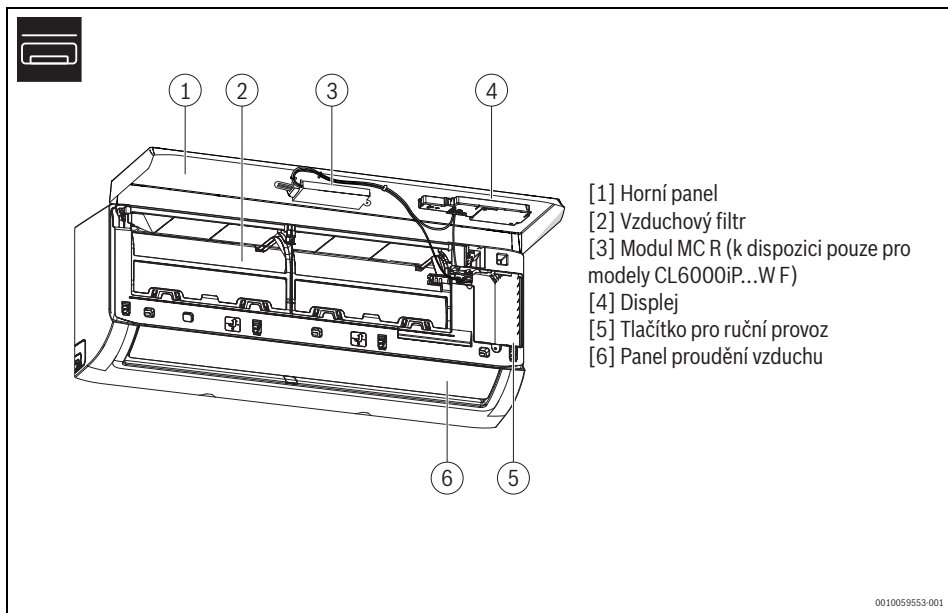

Obr. 8

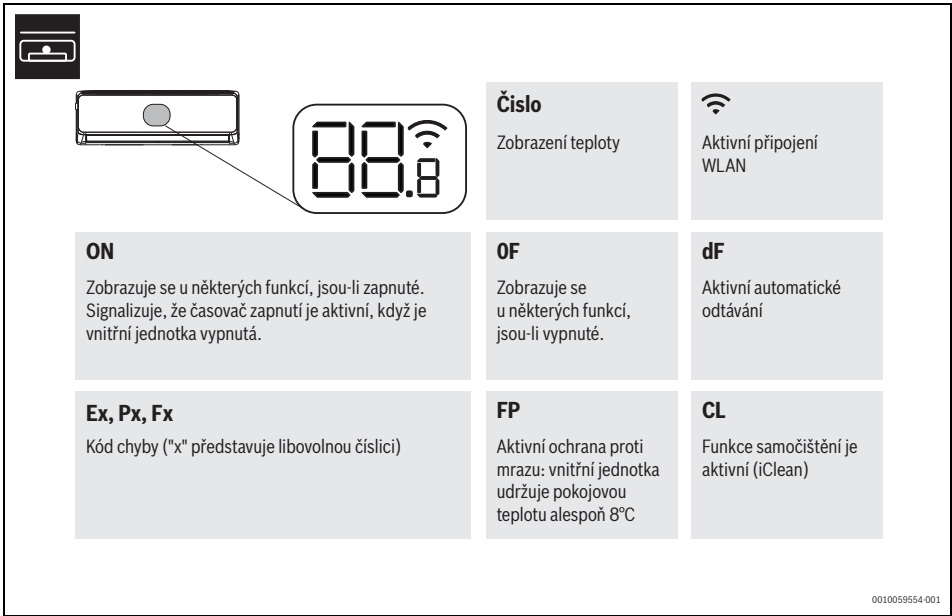

Obr. 9

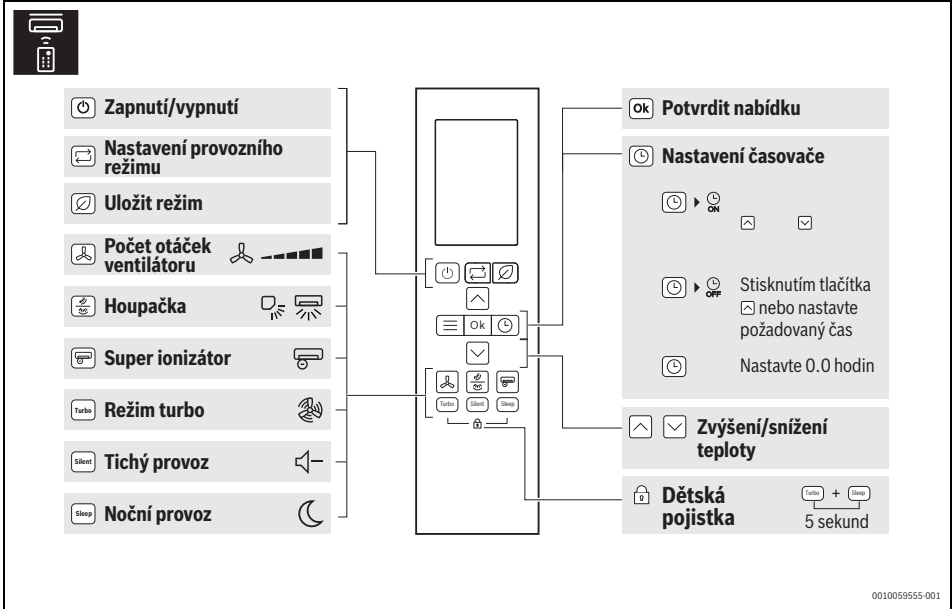

Obr. 10

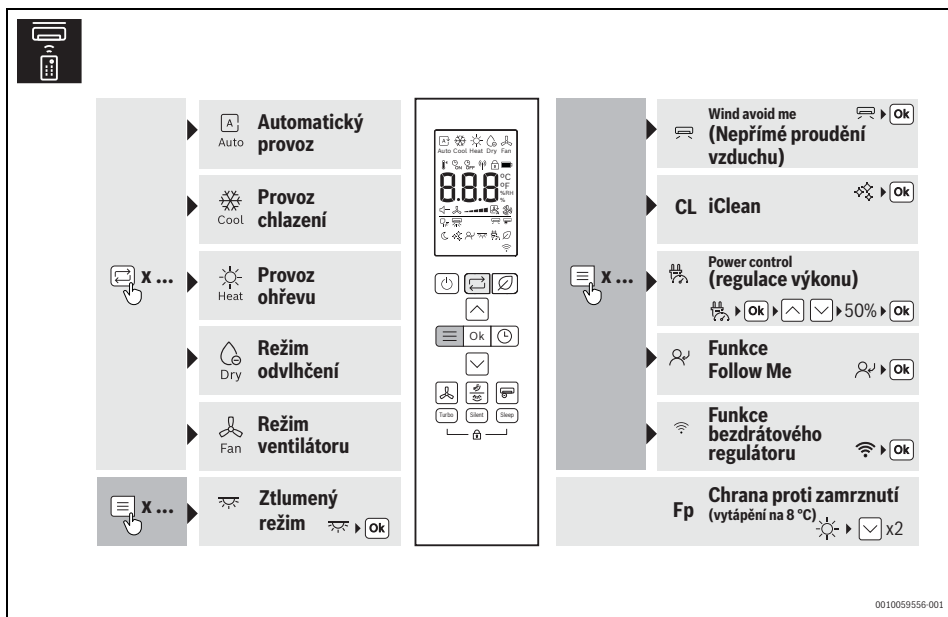

0010059556-001

Obr. 11

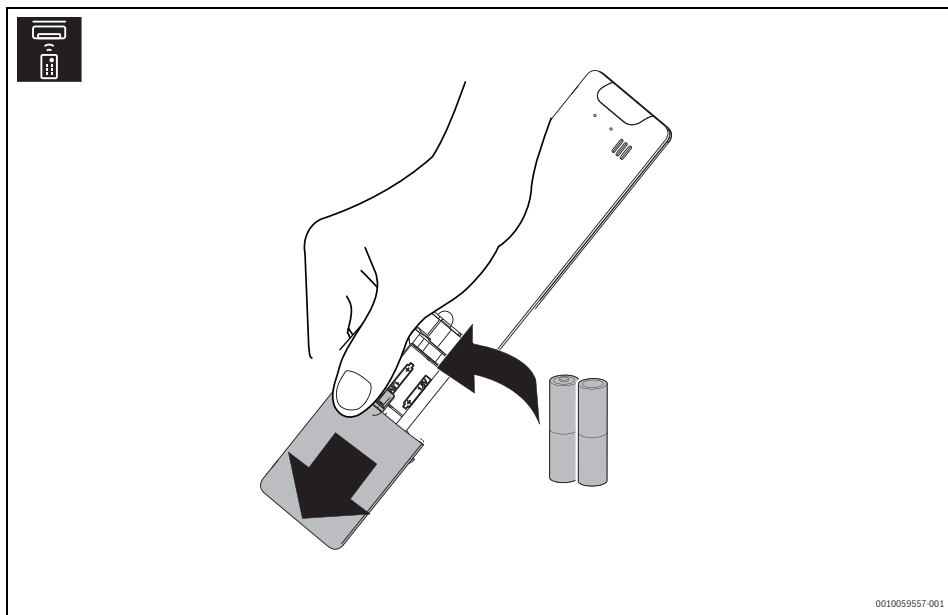

0010059557-001

Obr. 12

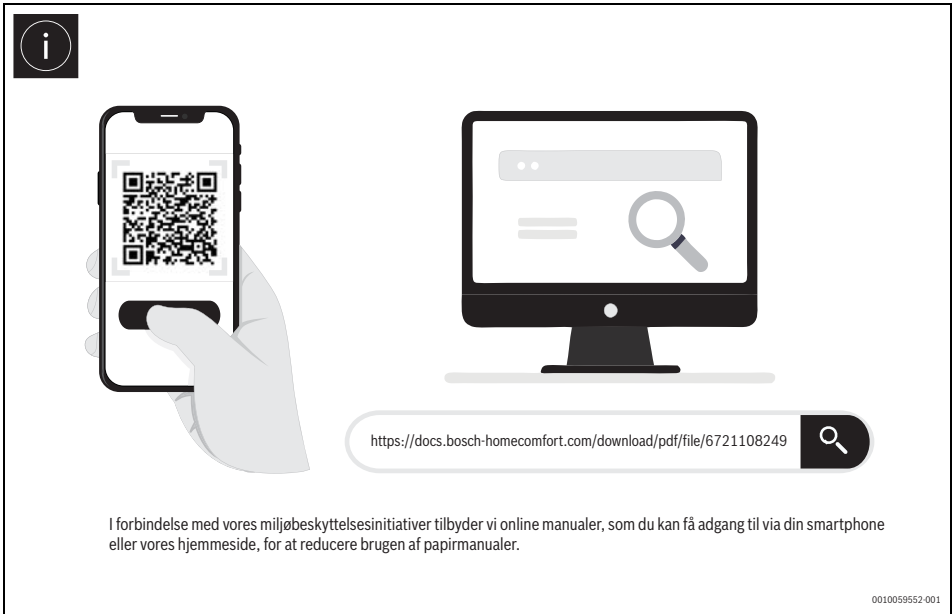

Fig. 13

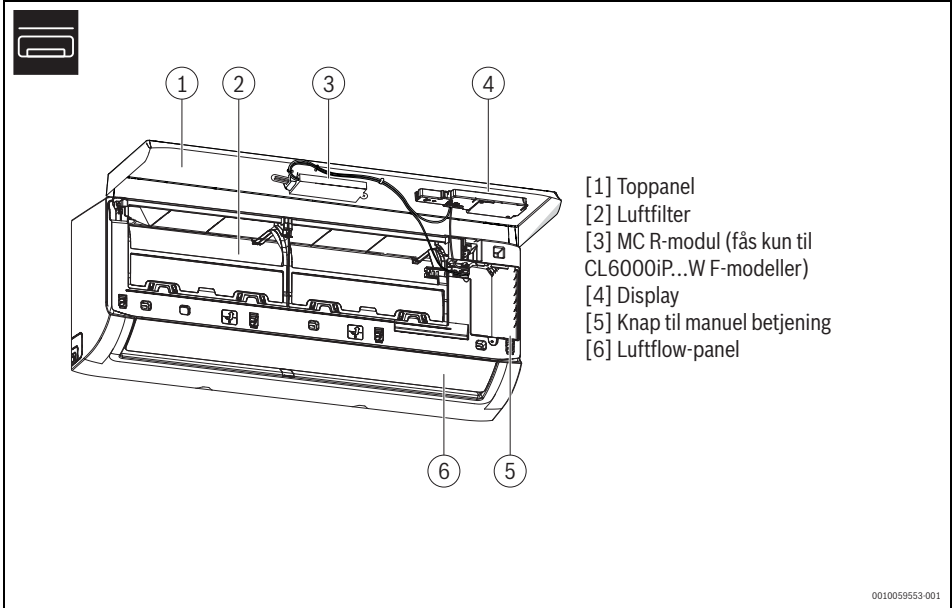

Fig. 14

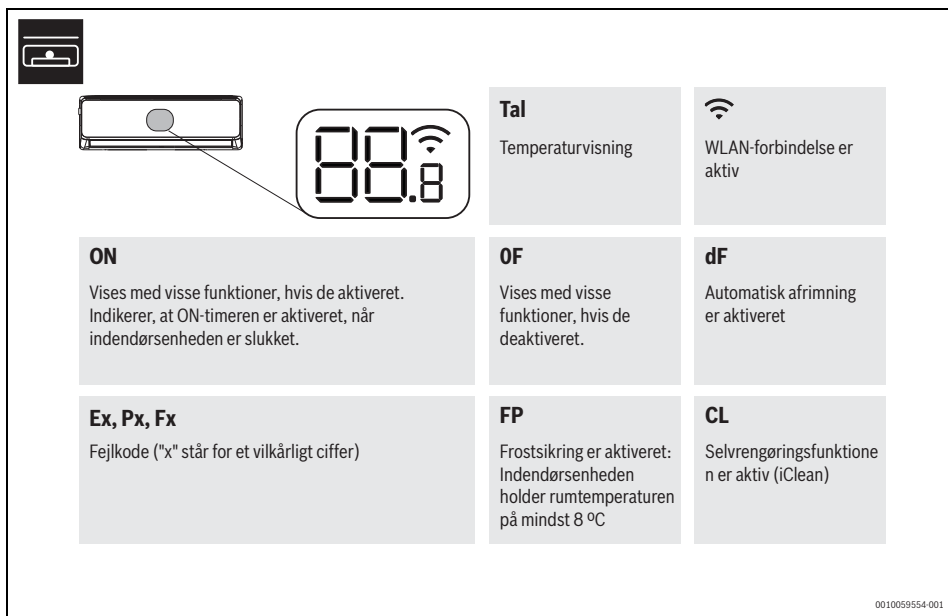

Fig. 15

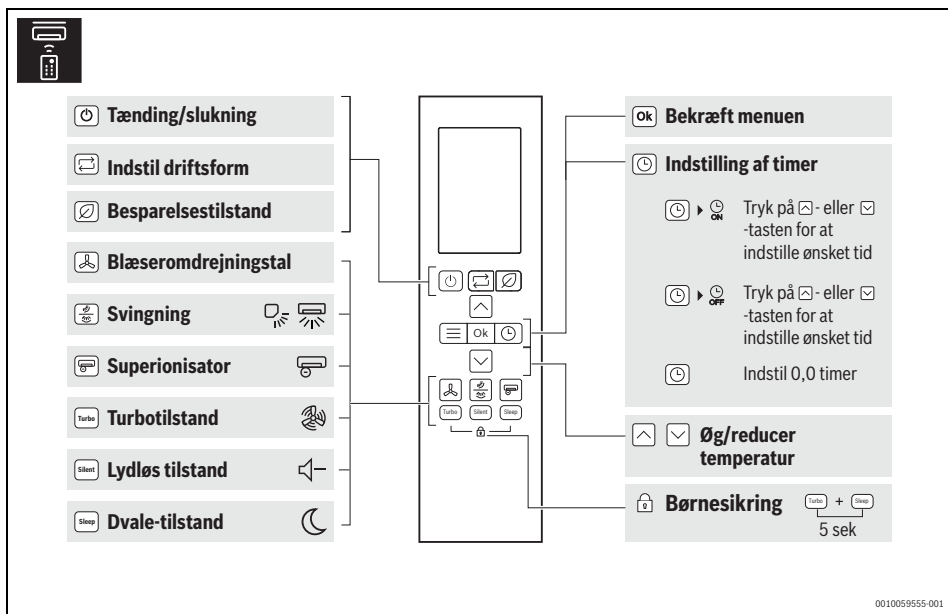

Fig. 16

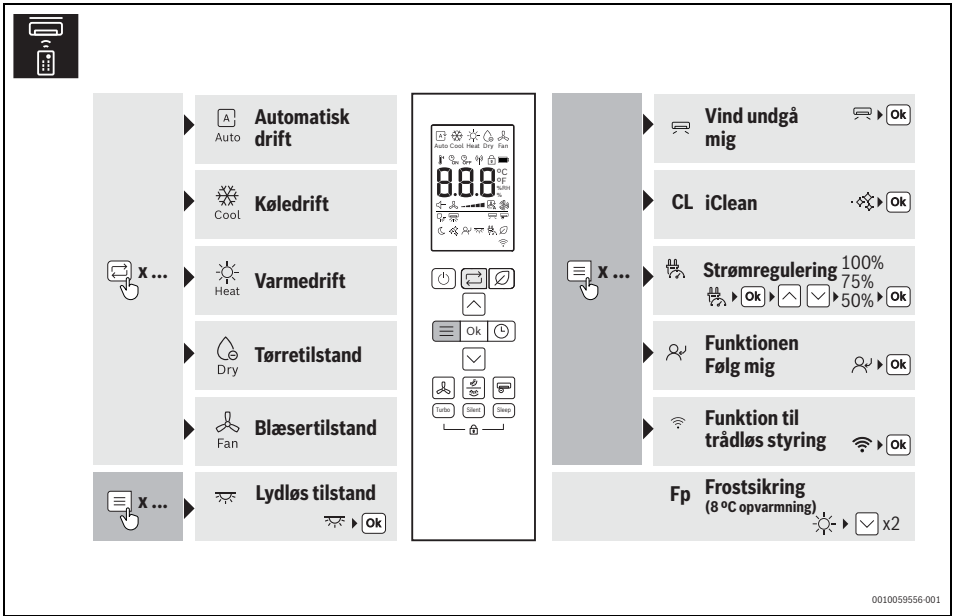

Fig. 17

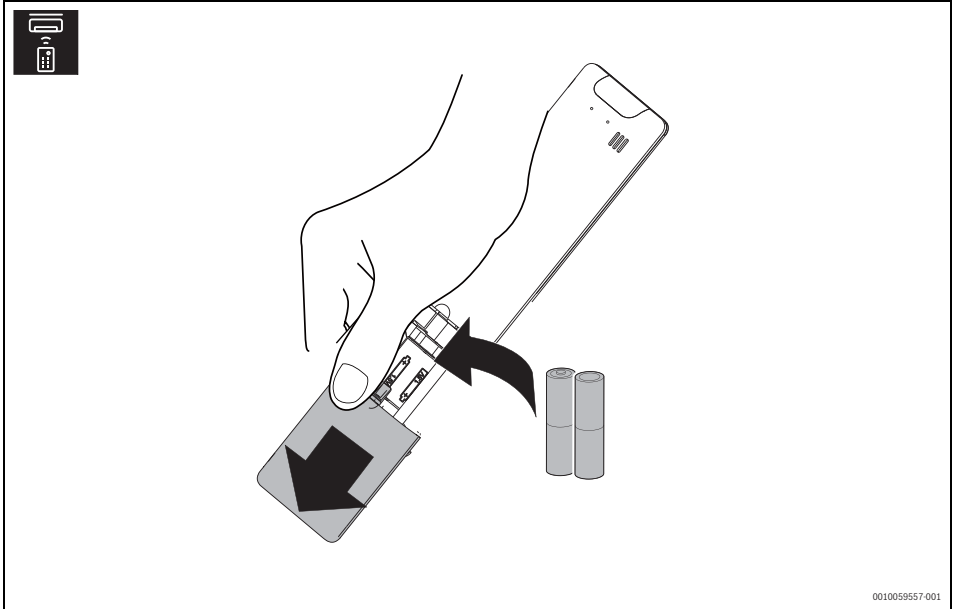

Fig. 18



Bild 19



Bild 20







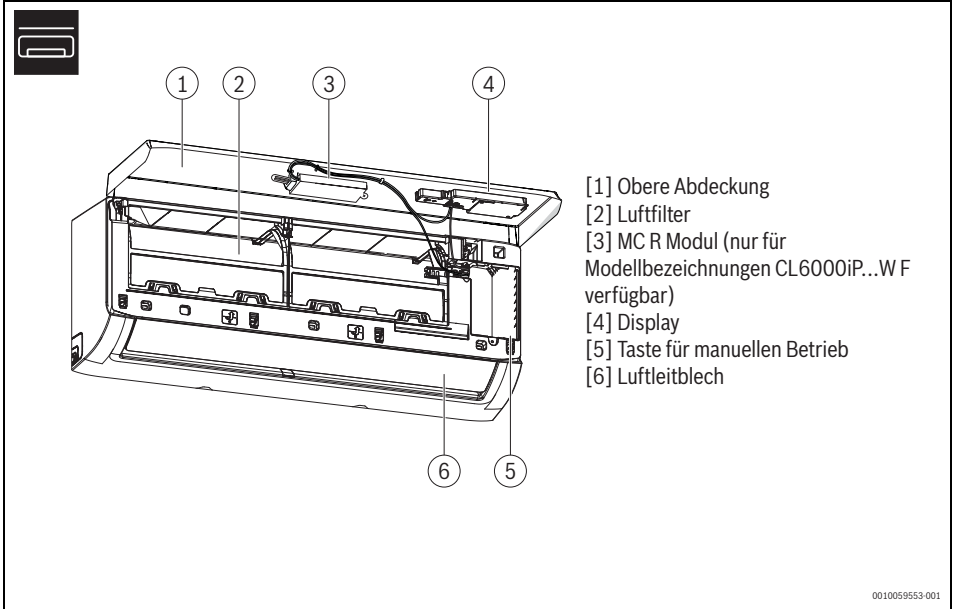
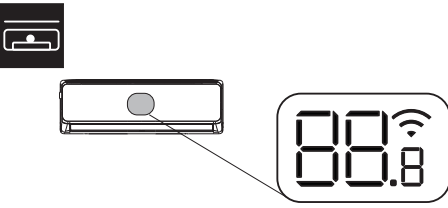





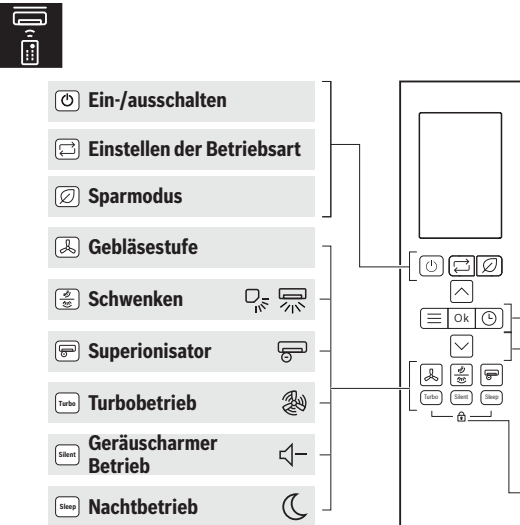







<p>EIN</p> <p>Wird bei manchen Funktionen angezeigt, wenn diese eingeschaltet werden. Zeigt bei ausgeschalteter Inneneinheit an, dass der</p>	<p>Numerer</p> <p>Temperaturanzeige</p>	<p></p> <p>WLAN Verbindung aktiv</p>
<p>Ex, Px, Fx</p> <p>Störungscode ("x" steht für eine beliebige Ziffer)</p>	<p>OF</p> <p>Wird bei manchen Funktionen angezeigt, wenn diese</p>	<p>dF</p> <p>Automatische Abtauung aktiv</p>
<p>Ex, Px, Fx</p> <p>Störungscode ("x" steht für eine beliebige Ziffer)</p>	<p>FP</p> <p>Frostschutz aktiv: Die Inneneinheit hält die Raumtemperatur auf mindestens 8 °C</p>	<p>CL</p> <p>Selbstreinigungsfunktion ist aktiv (iClean)</p>

Bild 21



<p> Ein-/ausschalten</p>	<p> Menü bestätigen</p>
<p> Einstellen der Betriebsart</p>	<p> Timer einstellen</p>
<p> Sparmodus</p>	<p> <input type="checkbox"/> - oder <input type="checkbox"/> -Taste drücken, um die gewünschte Zeit</p>
<p> Gebälsestufe</p>	<p> <input type="checkbox"/> - oder <input type="checkbox"/> -Taste drücken, um die gewünschte Zeit</p>
<p> Schwenken</p>	<p> 0,0 Stunden einstellen</p>
<p> Superionisator</p>	<p> Temperatur erhöhen/absenken</p>
<p> Turbobetrieb</p>	<p> Kindersicherung  +  5 s</p>
<p> Geräuscharmer Betrieb</p>	
<p> Nachtbetrieb</p>	

0010059555-001

Bild 22

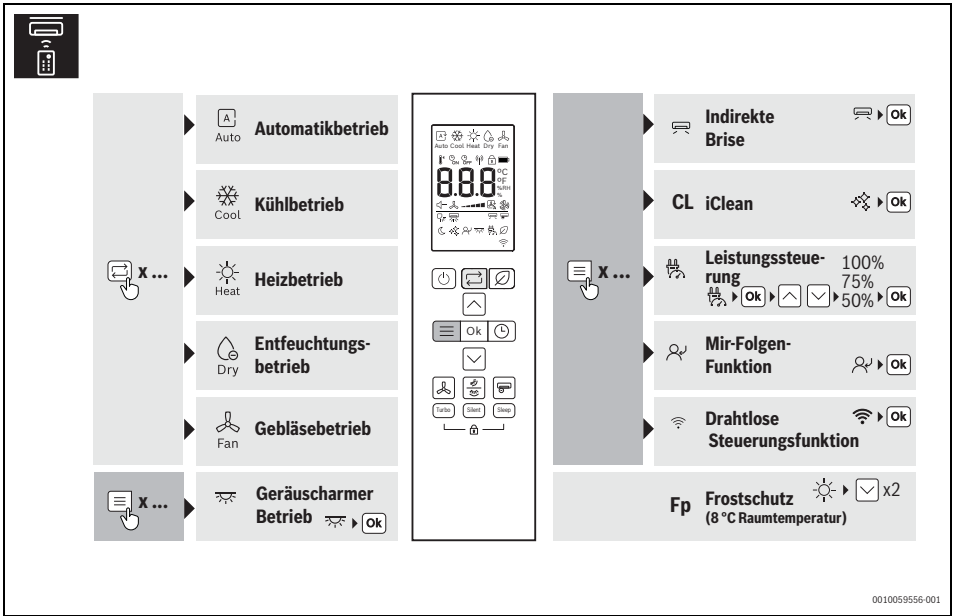

0010059556-001

Bild 23

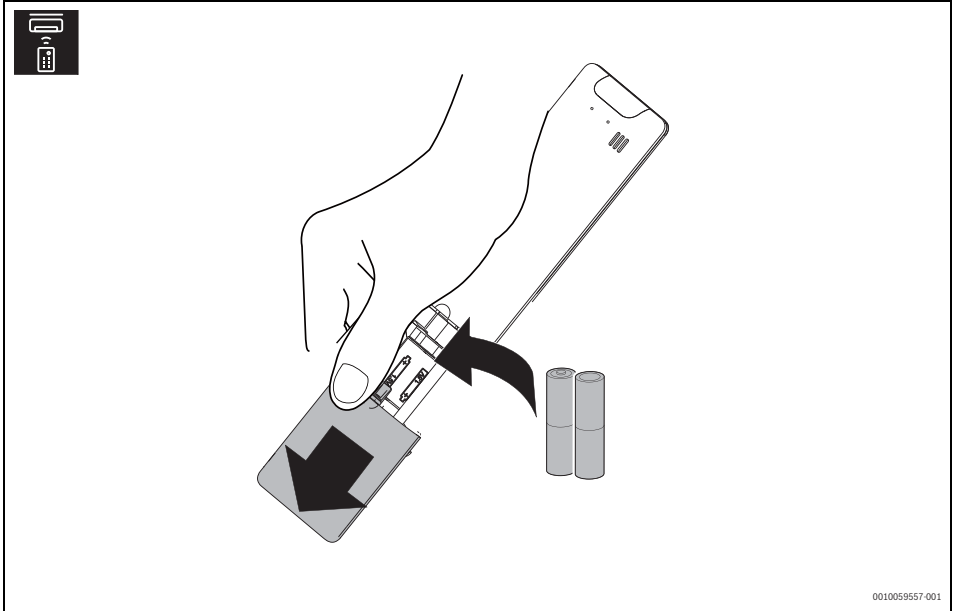

0010059557-001

Bild 24

i

<https://docs.bosch-homecomfort.com/download/pdf/file/6721108249>

Μέρος των πρωτοβουλιών μας για την περιβαλλοντική προστασία, παρέχουμε ηλεκτρονικά εγχειρίδια χρήσης που είναι προσβάσιμα μέσω του δικού σας smartphone ή του διαδικτυακού μας τόπου για να βοηθήσουμε στην μείωση των εγχαρτων εγχειριδίων χρήσης.

0010059552-001

Σχ. 25

- [1] Επάνω πλαίσιο
- [2] Φίλτρο αέρα
- [3] MC R βαθμίδα (διατίθεται μόνο για τα μοντέλα C16000iP...W F)
- [4] Οθόνη
- [5] Πλήκτρο για χειροκίνητη λειτουργία
- [6] Πλαίσιο ροής αέρα

0010059553-001

Σχ. 26

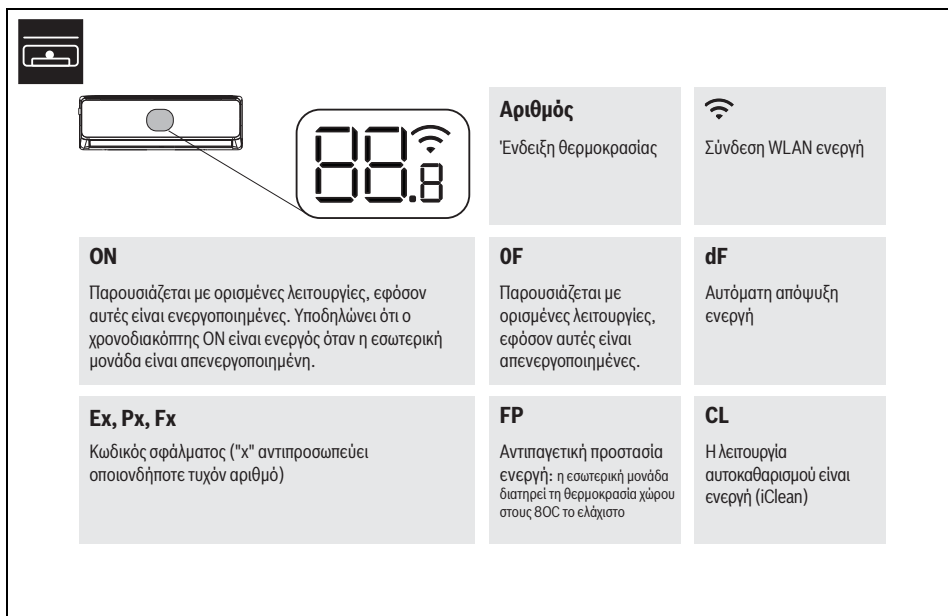

Σχ. 27

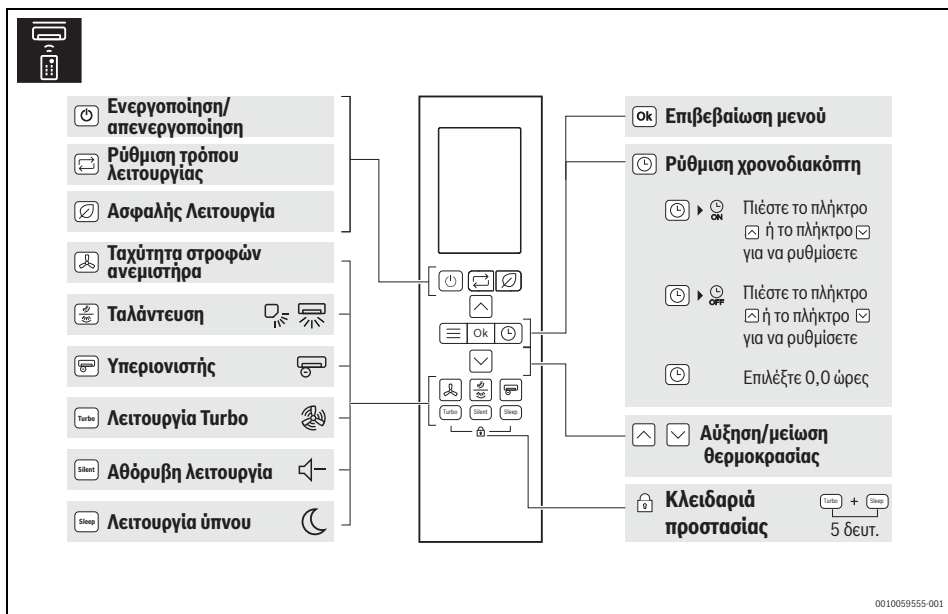

Σχ. 28

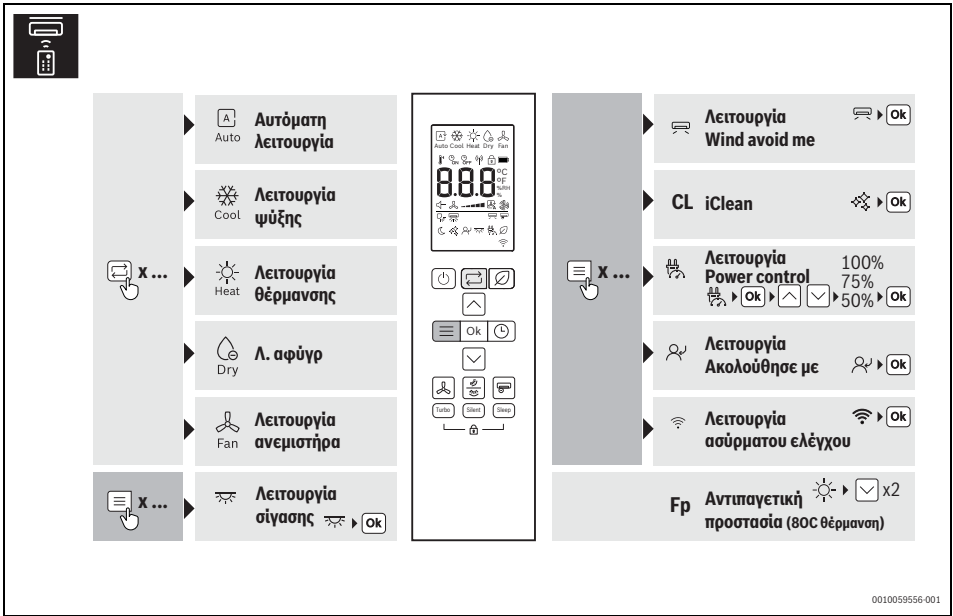

Σχ. 29

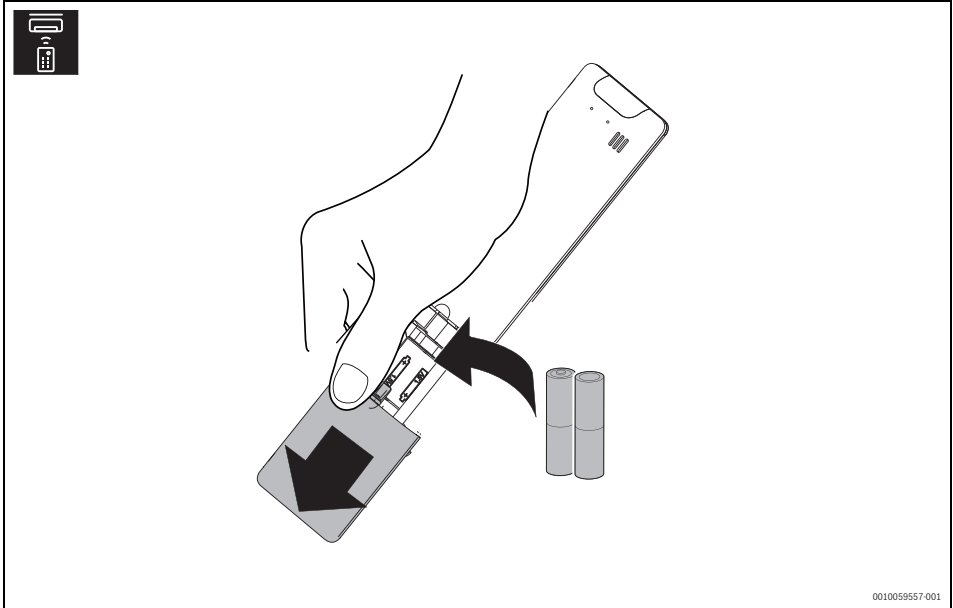

Σχ. 30

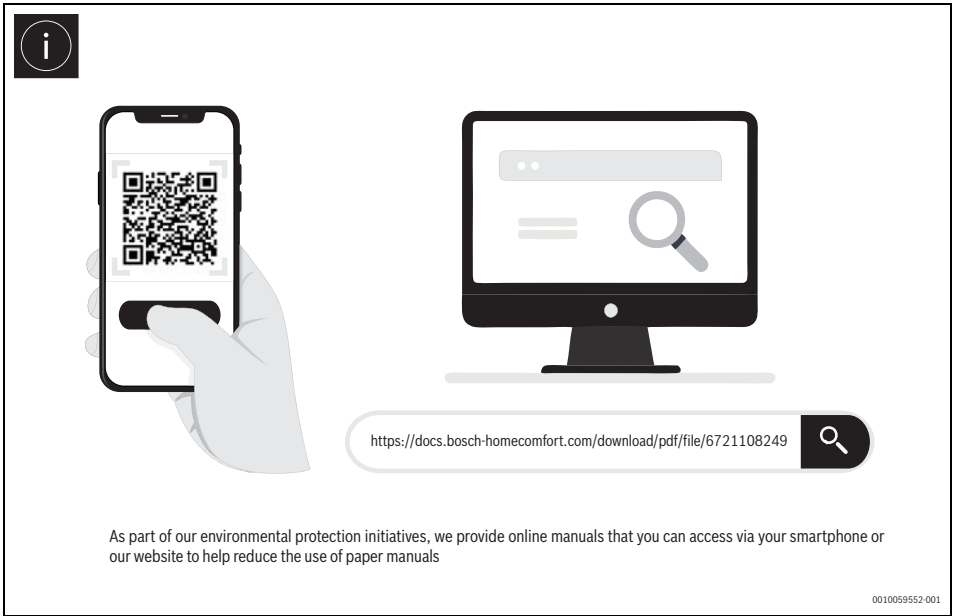

Fig. 31

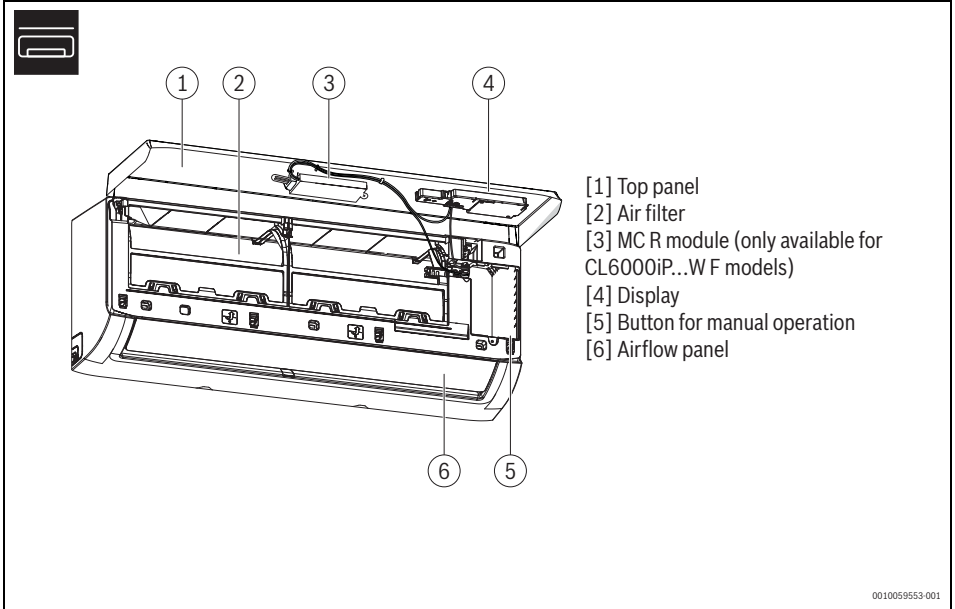

Fig. 32

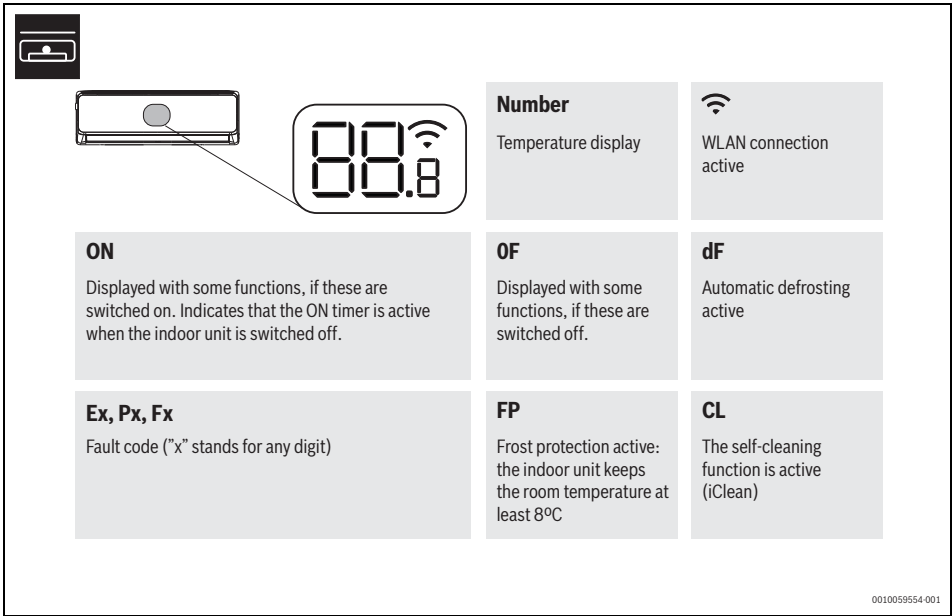

Fig. 33

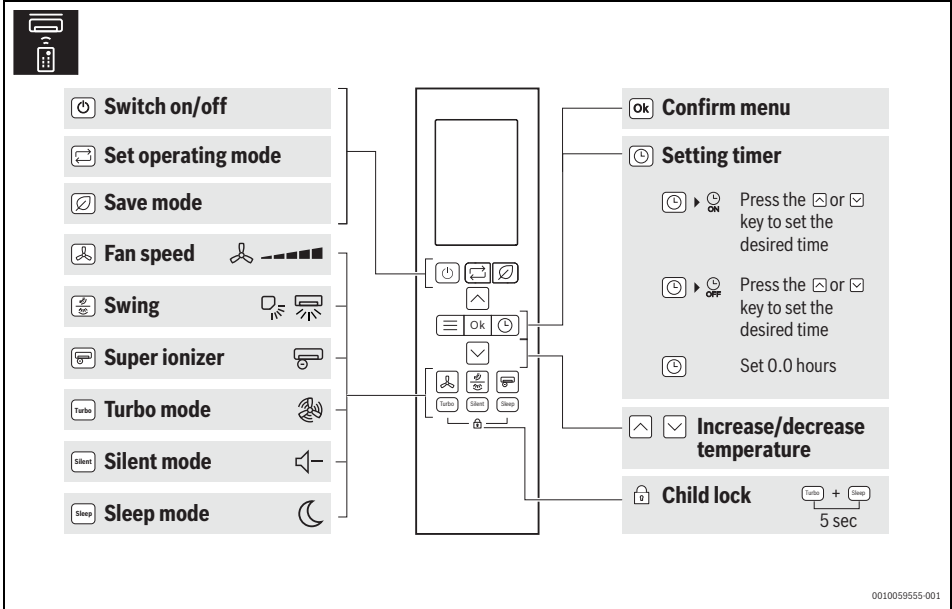

Fig. 34

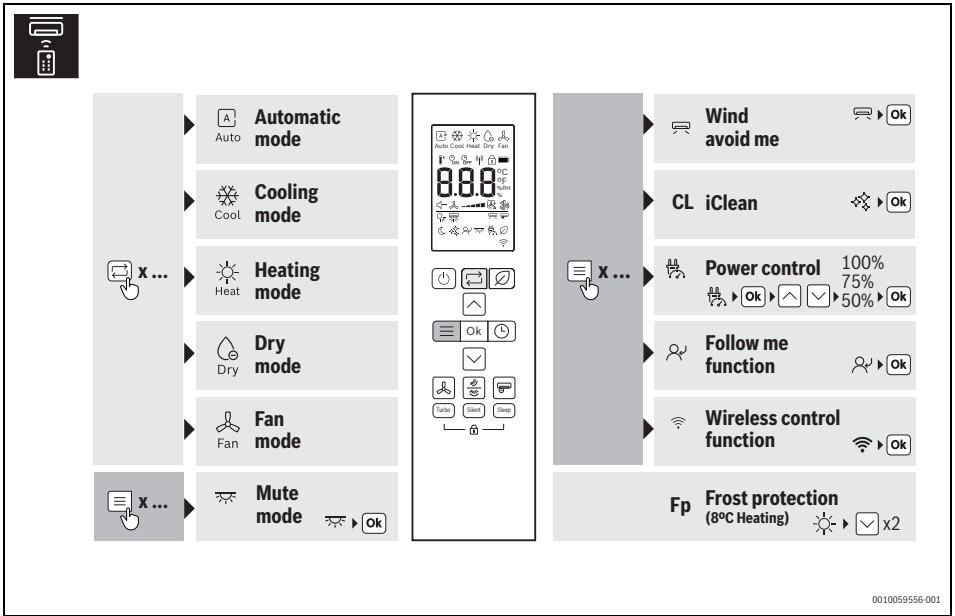

Fig. 35

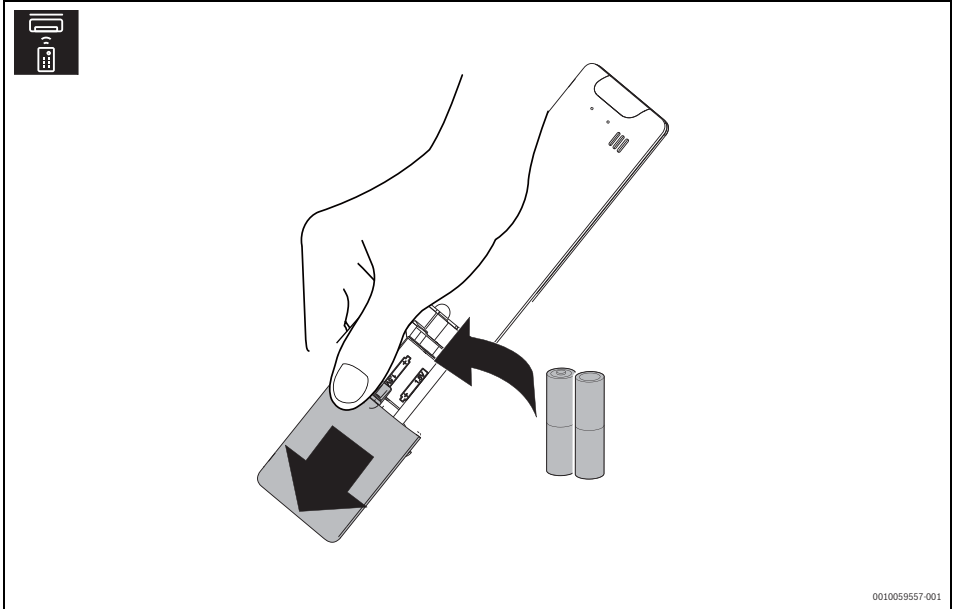

Fig. 36

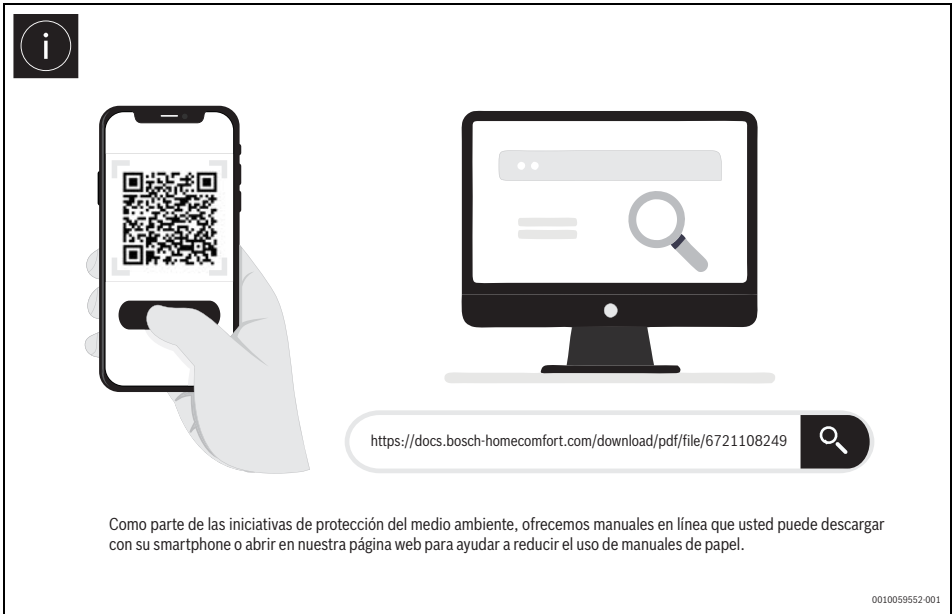

Fig. 37

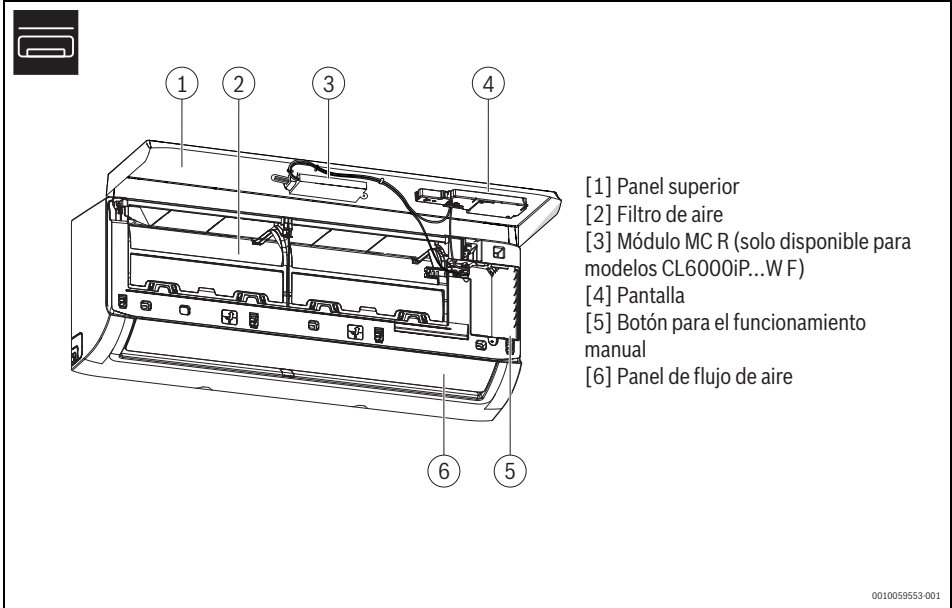

Fig. 38

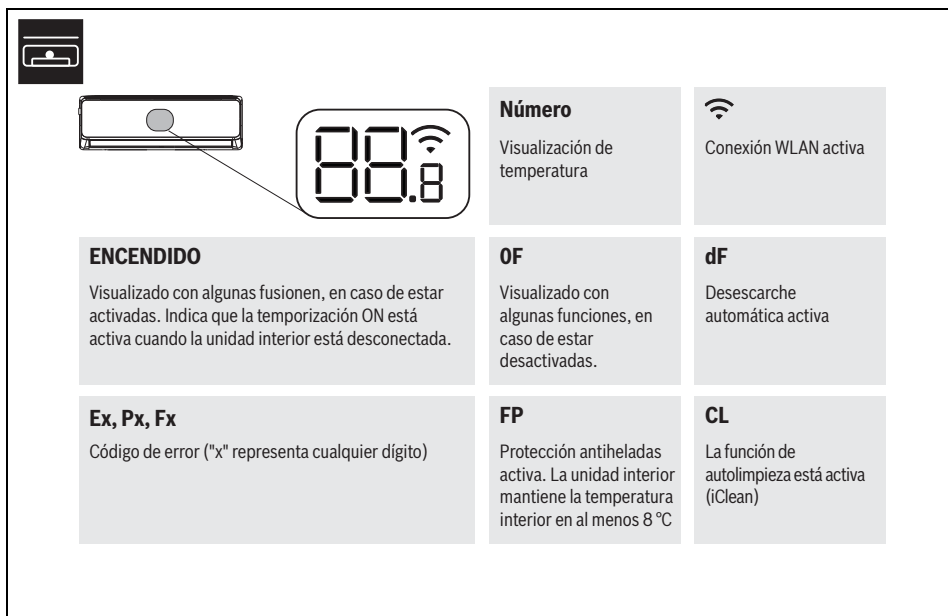

Fig. 39

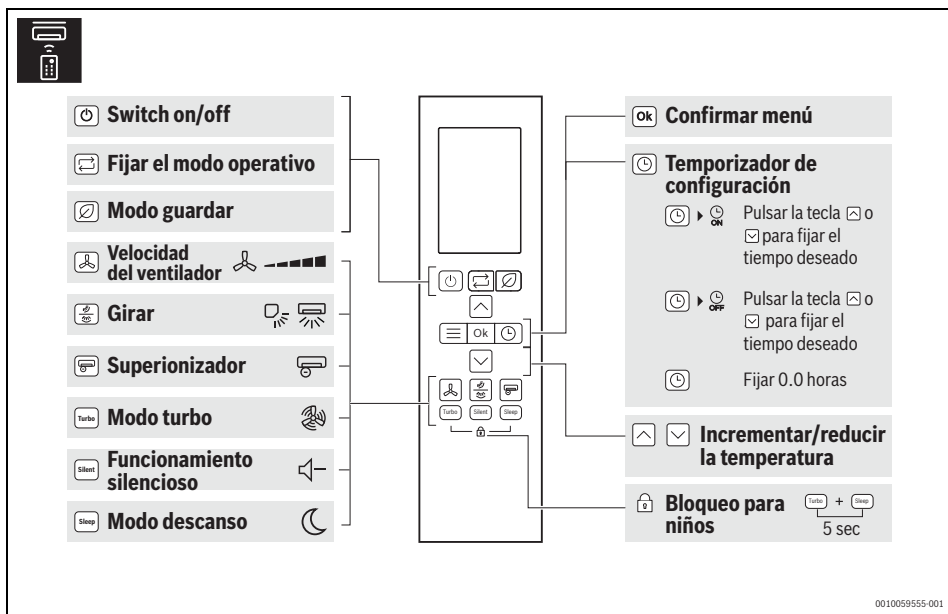

Fig. 40

0010059555-001

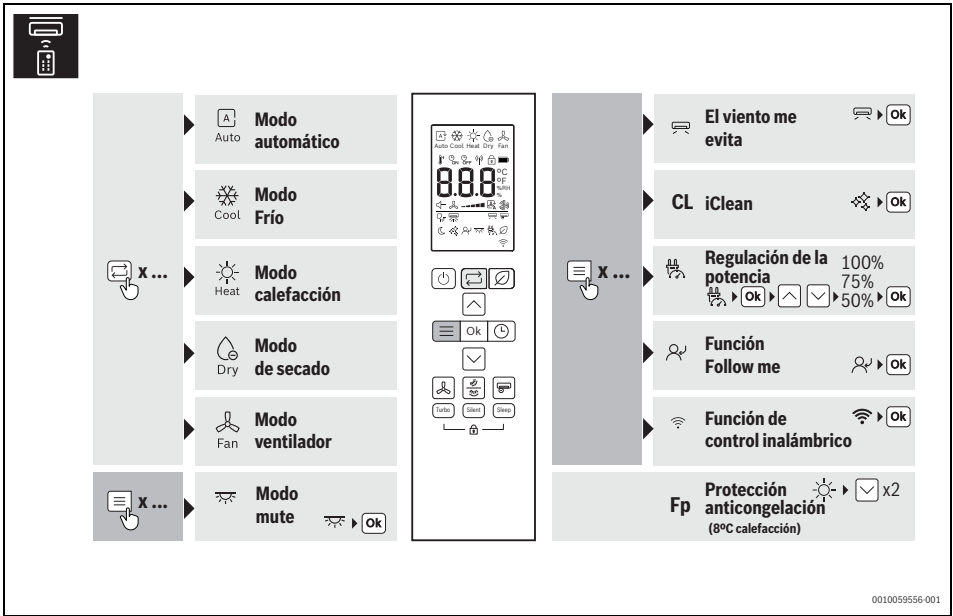

Fig. 41

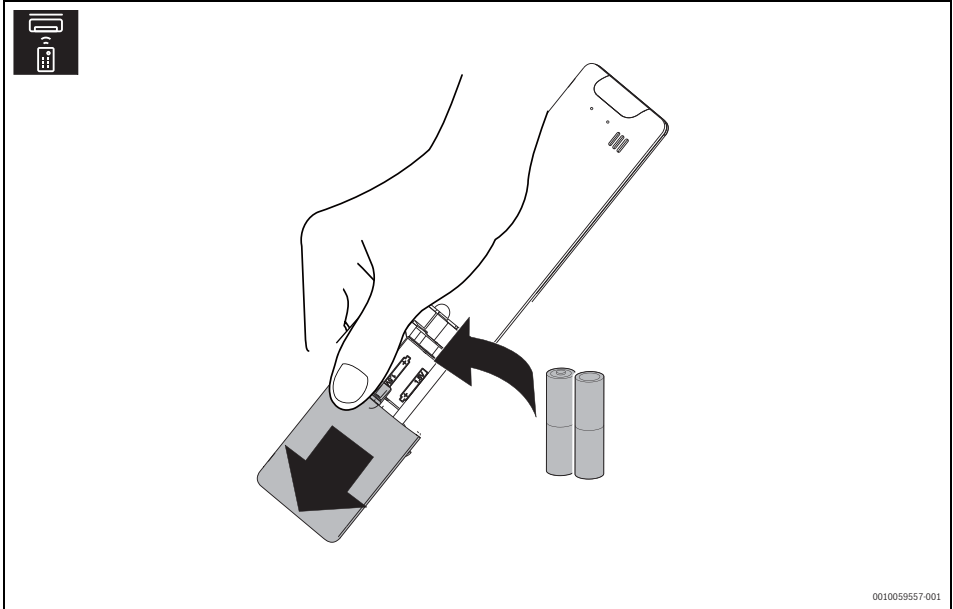
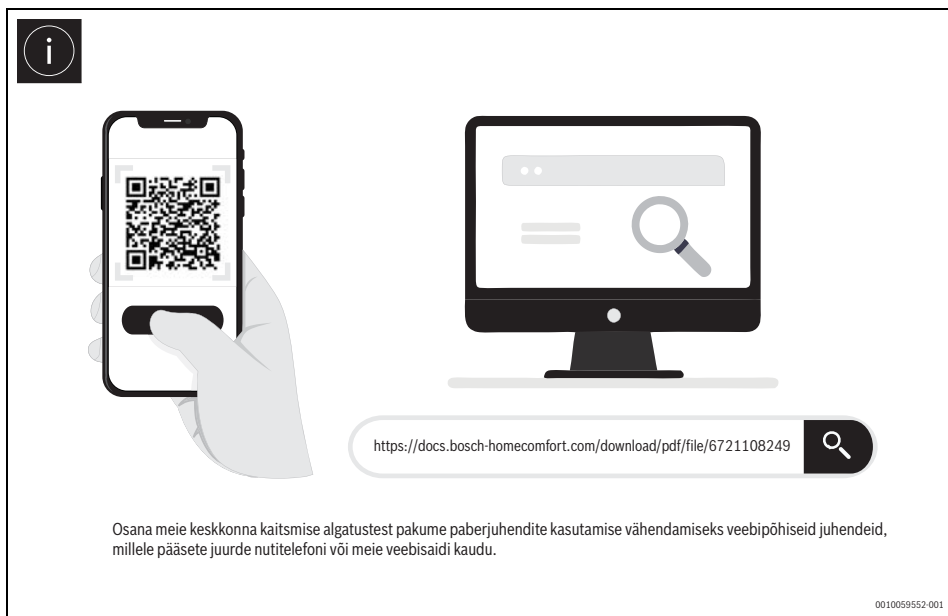
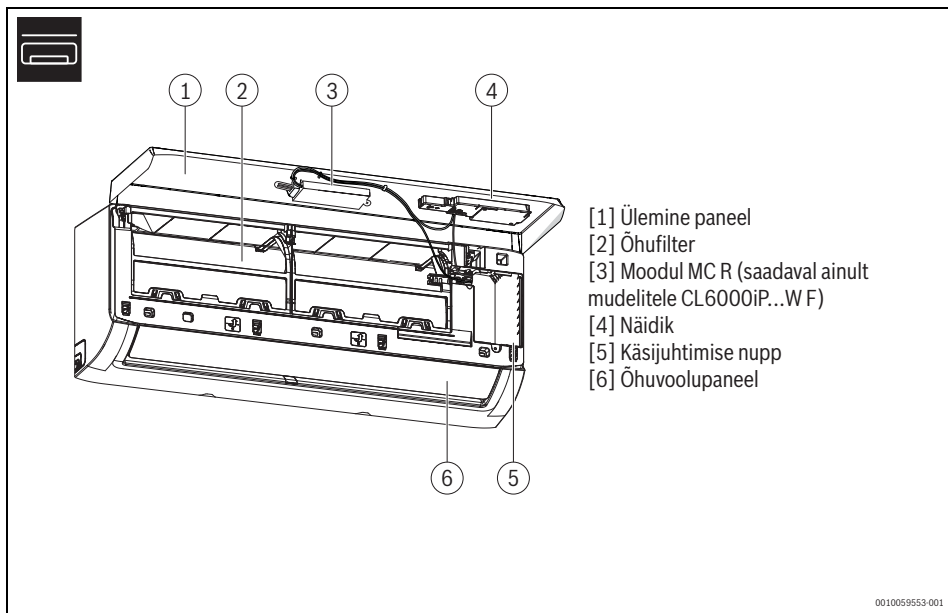

Fig. 42



Joon. 43



Joon. 44

Number
Temperatuurinäidik

SEES
Kuvatakse koos mõne funktsiooniga, kui need on sisse lülitatud. Näitab, et SISSElülituskell on aktiivne, kui siseüksus on välja lülitatud.

OF
Kuvatakse koos mõne funktsiooniga, kui need on välja lülitatud.

Ex, Px, Fx
Tõrkekood (x tähistab mis tahes numbrit)

FP
Külmumiskaitse sees: siseüksus hoiab ruumitemperatuuri minimaalselt 8 °C juures

Wi-Fi
WLANi ühendus aktiivne

dF
Automaatne sulatamine aktiivne

CL
Isepuhastumise funktsioon on aktiveeritud (iClean)

Joon. 45

Sisse-/väljalülitamine

Kasutusviisi valimine

Salvestusrežiim

Ventilaatori pöörete arv

Pendeldamine

Superionisaator

Turbo režiim

Vaikne režiim

Unerežiim

OK Kinnitamise menüü

Lülituskella seadistamine
 Vajutage klahvi või , et määrata soovitud kellaageg
 Vajutage klahvi või , et määrata soovitud kellaageg
 Seadke 0.0 tundi

Temperatuuri tõstmine/langetamine

Lapselukk + 5 s

0010059555-001

Joon. 46

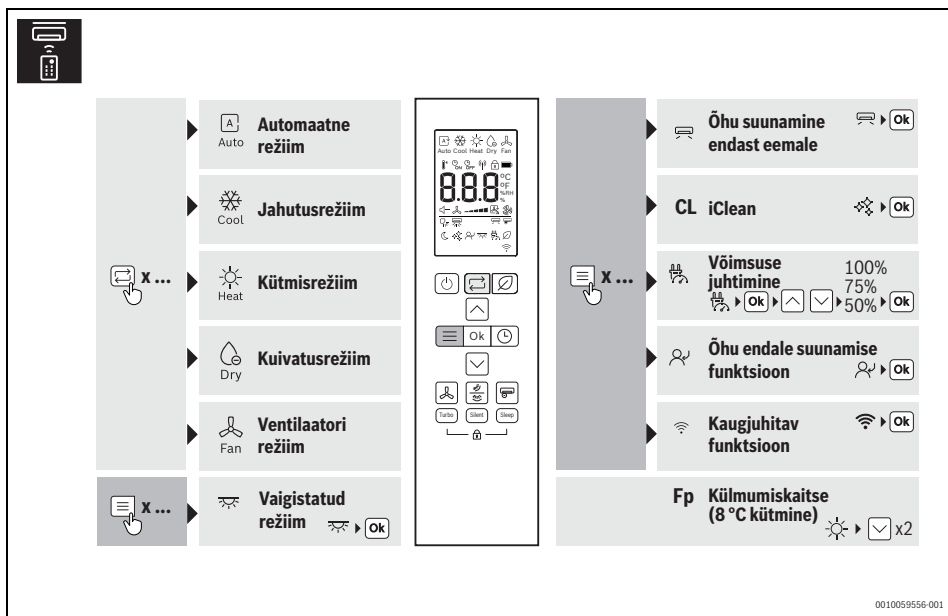

Joon. 47

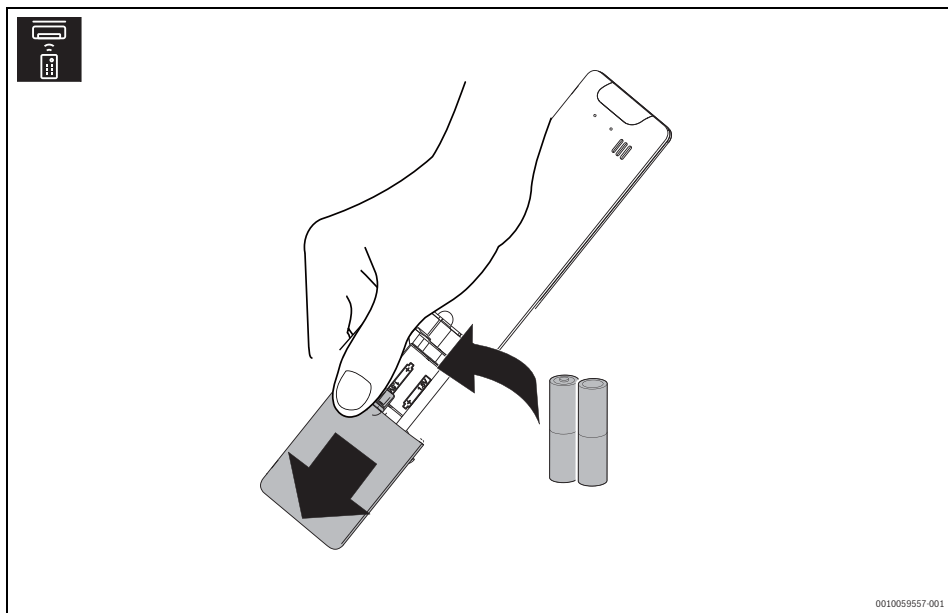

Joon. 48

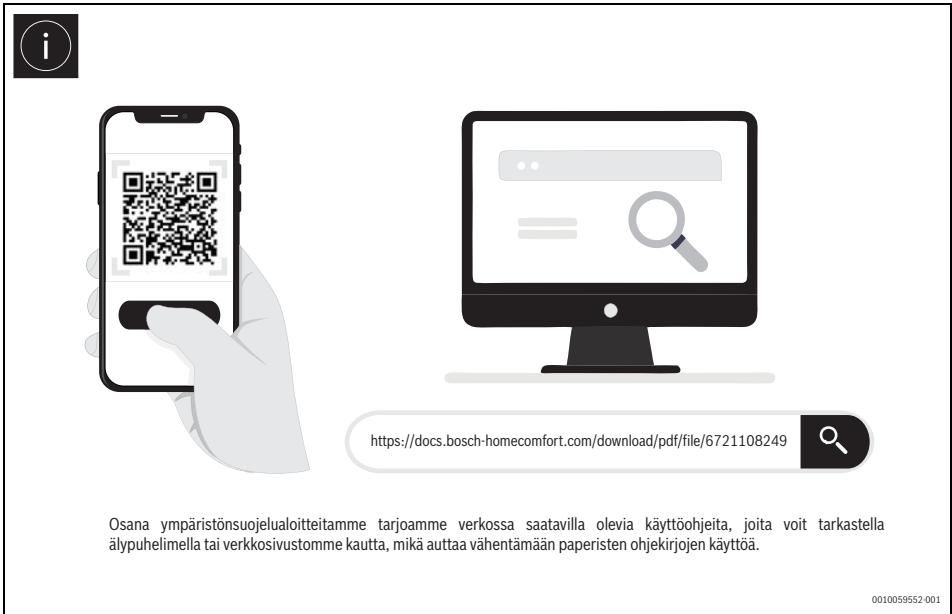

Kuva 49

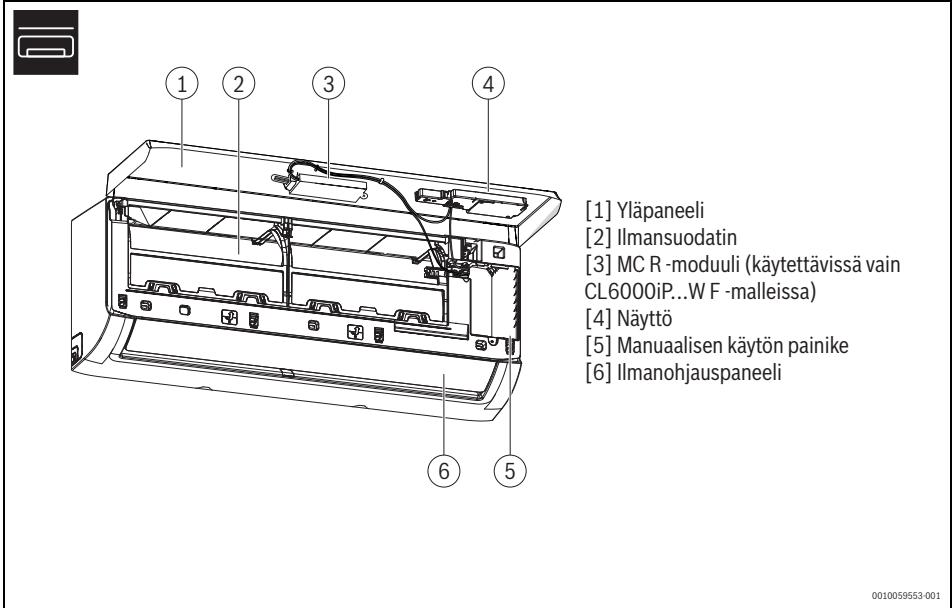



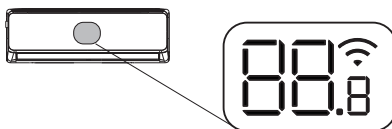





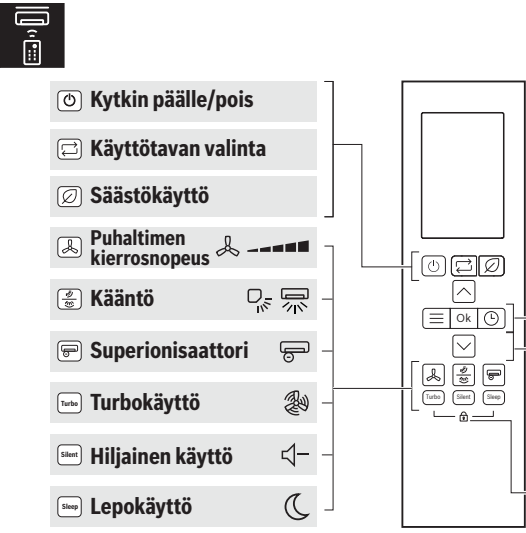























Kuva 50



<p>PÄÄLLÄ</p> <p>Näytetään joidenkin toimintojen yhteydessä, jos nämä toiminnot kytketään päälle. Osoittaa, että PÄÄLLE-ajastin on aktiivinen, kun sisäyksikkö sammutetaan.</p>	<p>Numero</p> <p>Lämpötilänäyttö</p>	<p></p> <p>WLAN-yhteys aktiivinen</p>
<p>Ex, Px, Fx</p> <p>Vikakoodi ("x" tarkoittaa mitä tahansa numeroa)</p>	<p>OF</p> <p>Näytetään joidenkin toimintojen yhteydessä, jos nämä toiminnot kytketään</p>	<p>dF</p> <p>Automaattinen sulatus aktiivinen</p>
	<p>FP</p> <p>Jäätymisenesto aktiivinen: sisäyksikkö pitää huoneen lämpötilan vähintään 8 °C:ssa</p>	<p>CL</p> <p>Itsepuhdistustoiminto on aktiivinen (iClean)</p>

Kuva 51



<p> Kytkin päälle/pois</p>	<p>OK Vahvista valikko</p>
<p> Käyttötavan valinta</p>	<p> Ajastimen asettaminen</p>
<p> Säästökäyttö</p>	<p>  Aseta haluamasi aika painamalla painiketta  tai </p>
<p> Puhaltimen kierrosnopeus </p>	<p>  Aseta haluamasi aika painamalla painiketta  tai </p>
<p> Kääntö </p>	<p> Aseta ajaksi 0,0 tuntia</p>
<p> Superionisaattori </p>	<p>  Lämpötilan lisääminen /alentaminen</p>
<p> Turbokäyttö </p>	<p> Lapsilukko    5 sek</p>
<p> Hiljainen käyttö </p>	
<p> Lepokäyttö </p>	

0010059555-001

Kuva 52

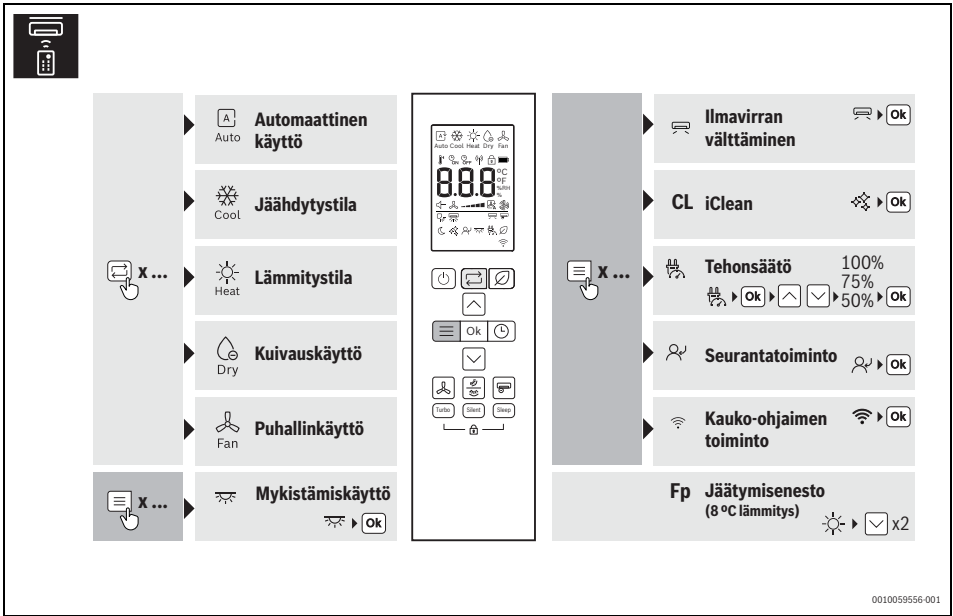

Kuva 53

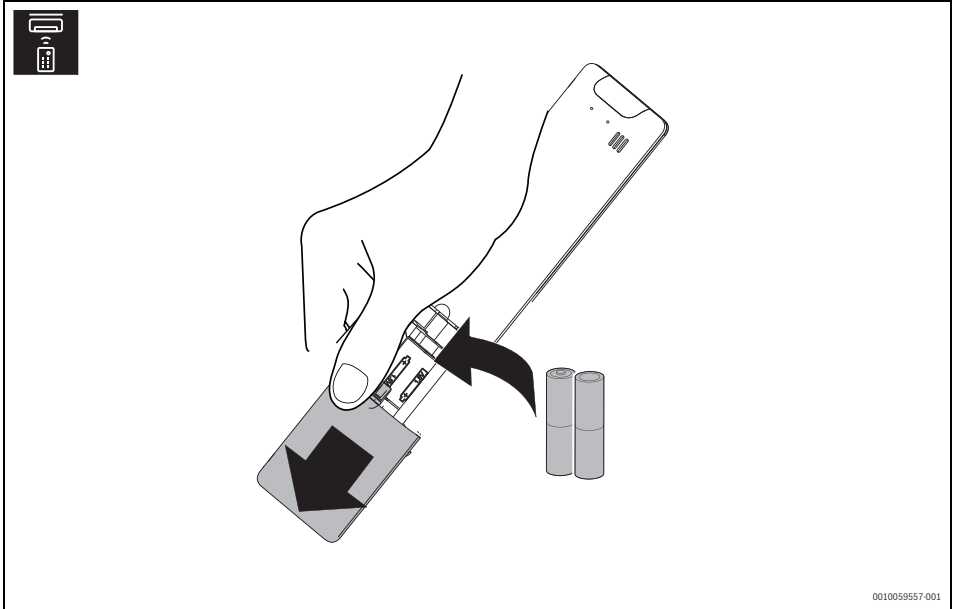

Kuva 54

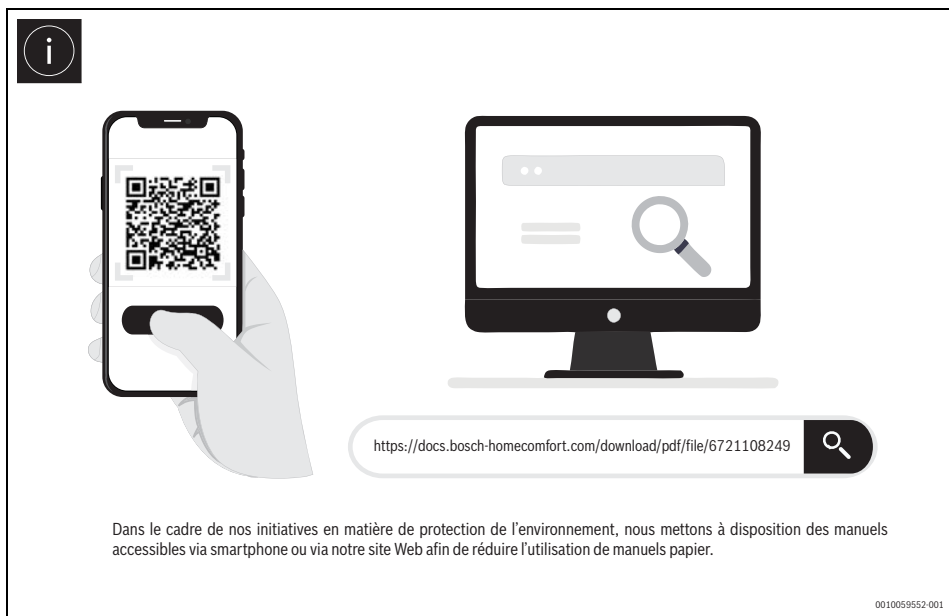

Fig. 55

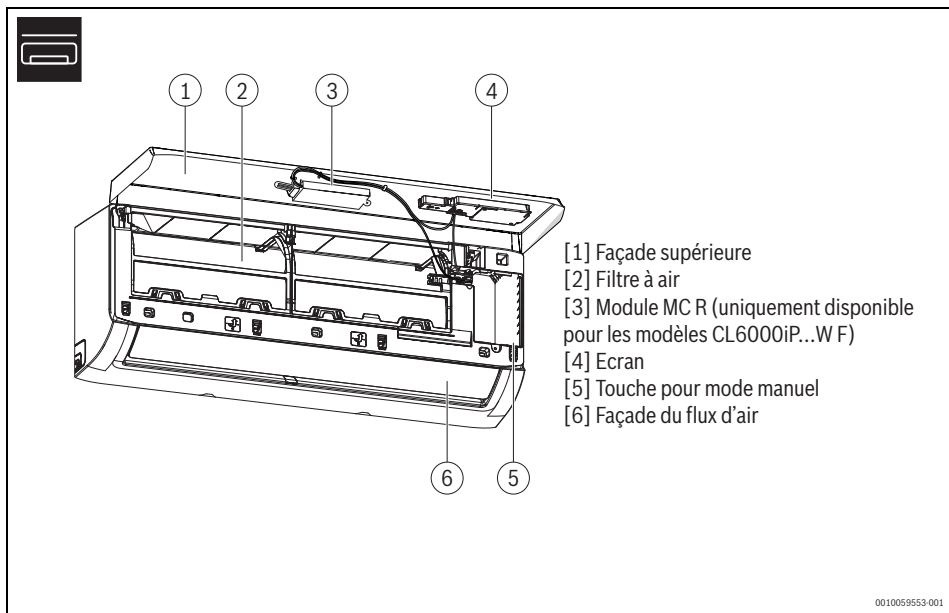

Fig. 56

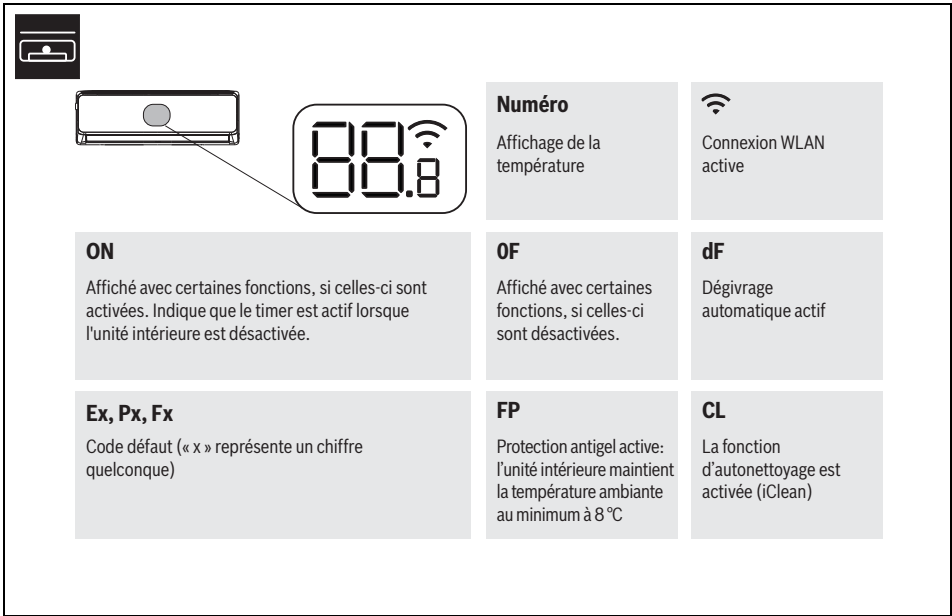

Fig. 57

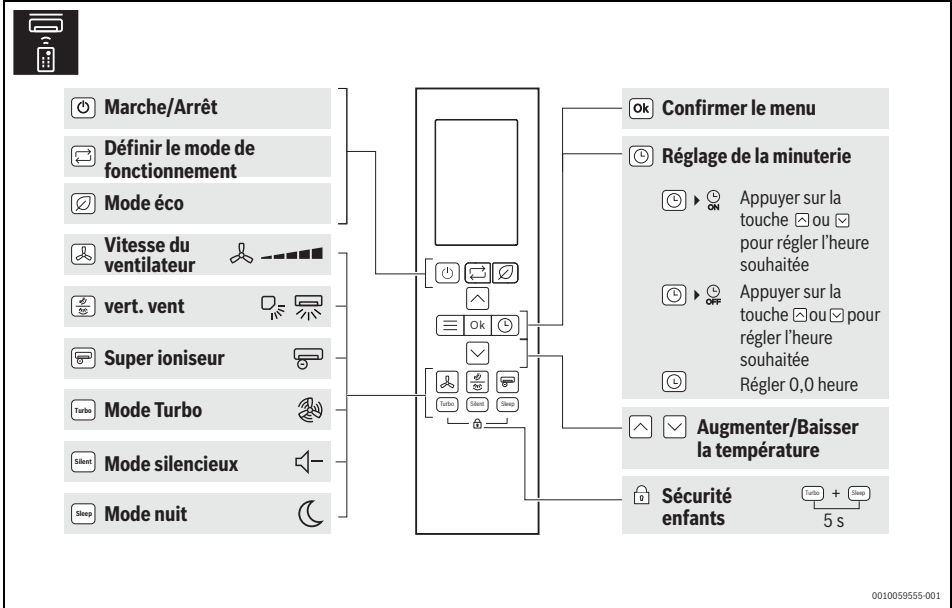
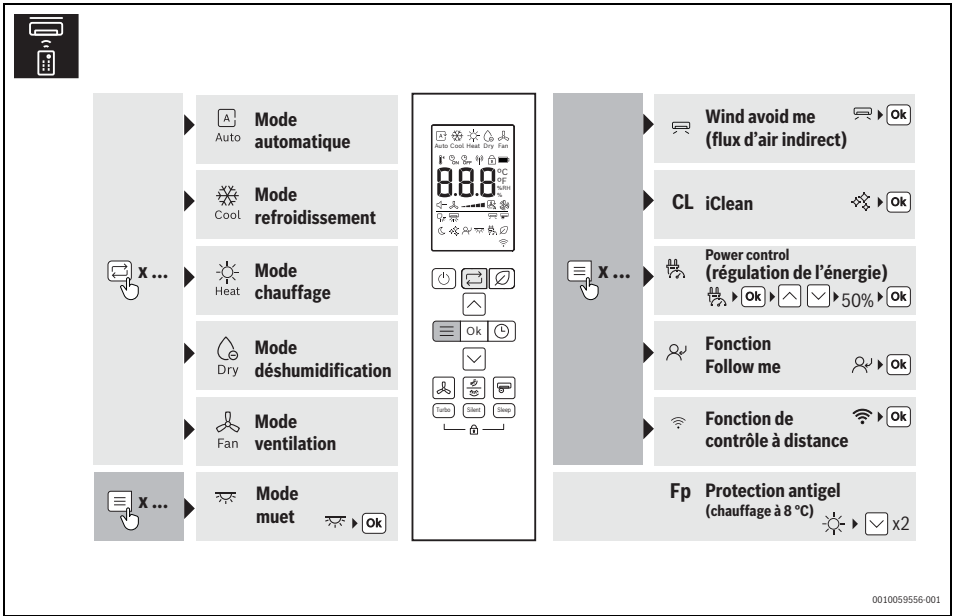

Fig. 58

0010059555-001



0010059556-001

Fig. 59

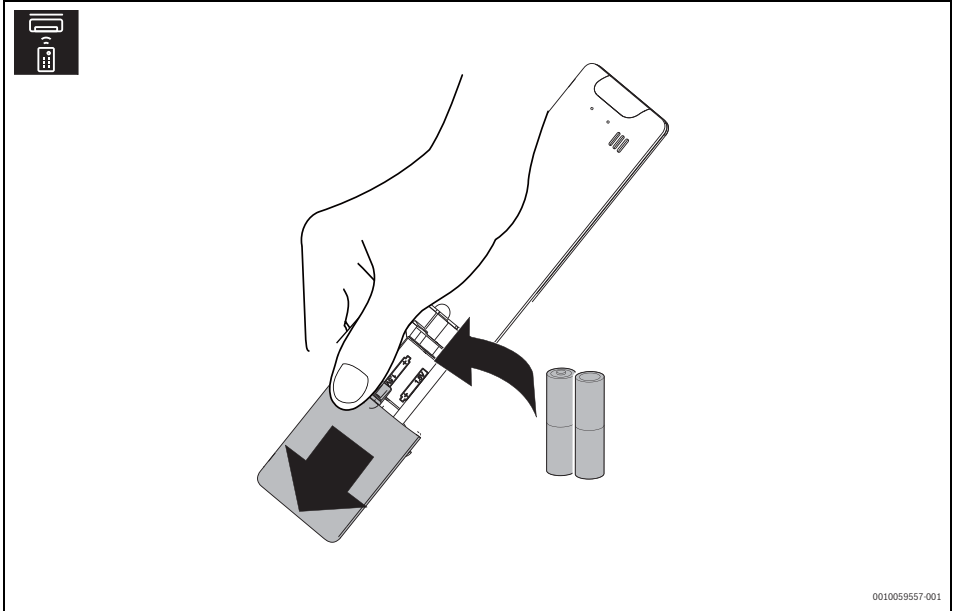

0010059557-001

Fig. 60

i

https://docs.bosch-homecomfort.com/download/pdf/file/6721108249

🔍

U sklopu inicijativa za zaštitu okoliša, mrežnim priručnicima možete pristupiti svojim pametnim telefonom ili putem naše web adrese kako bismo pomogli u smanjivanju uporabe papirnatih priručnika.

0010059552.001

SI.61

🔧

[1] Gornji poklopac
 [2] Filter zraka
 [3] MC R modul (dostupan samo za modele CL6000iP...W F)
 [4] Zaslon
 [5] Tipka za ručni način rada
 [6] Panel za protok zraka

0010059553.001



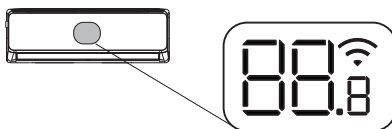





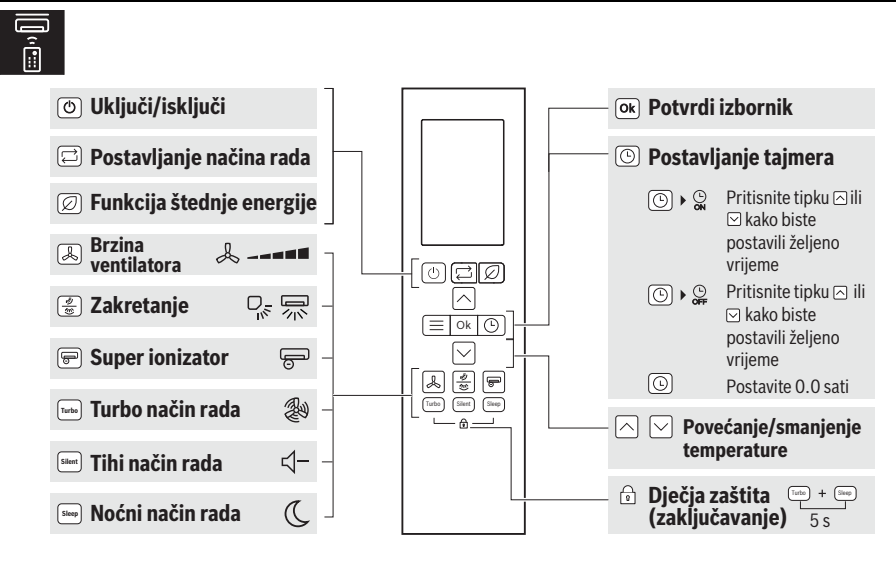















SI.62



<p>Uključeno</p> <p>Prikazuje se uz neke funkcije ako su uključene. Označava da je tajmer za uključivanje aktivan, kada se unutarnja jedinica isključuje.</p>	<p>Broj</p> <p>Prikaz temperature</p>	<p></p> <p>WLAN veza je aktivna</p>
<p>Ex, Px, Fx</p> <p>Šifra (kod) greške ("x" označava bilo koju znamenku)</p>	<p>OF</p> <p>Prikazuje se uz neke funkcije ako su isključene.</p>	<p>dF</p> <p>Automatsko odmrzavanje aktivno (defrost)</p>
<p>Ex, Px, Fx</p> <p>Šifra (kod) greške ("x" označava bilo koju znamenku)</p>	<p>FP</p> <p>Zaštita od smrzavanja aktivna: unutarnja jedinica održava sobnu temperaturu na najmanje 8 °C</p>	<p>CL</p> <p>Aktivna je funkcija samočišćenja (iClean)</p>

SI.63



<p> Uključi/isključi</p>	<p> Potvrdi izbornik</p>
<p> Postavljanje načina rada</p>	<p> Postavljanje tajmera</p>
<p> Funkcija štednje energije</p>	<p>  Pritisnite tipku  ili  kako biste postavili željeno vrijeme</p>
<p> Brzina ventilatora</p>	<p>  Pritisnite tipku  ili  kako biste postavili željeno vrijeme</p>
<p> Zakretanje</p>	<p> Postavite 0.0 sati</p>
<p> Super ionizator</p>	<p>  Povećanje/smanjenje temperature</p>
<p> Turbo način rada</p>	<p> Dječja zaštita (zaključavanje)   5 s</p>
<p> Tihi način rada</p>	
<p> Noćni način rada</p>	

0010059555-001

SI.64

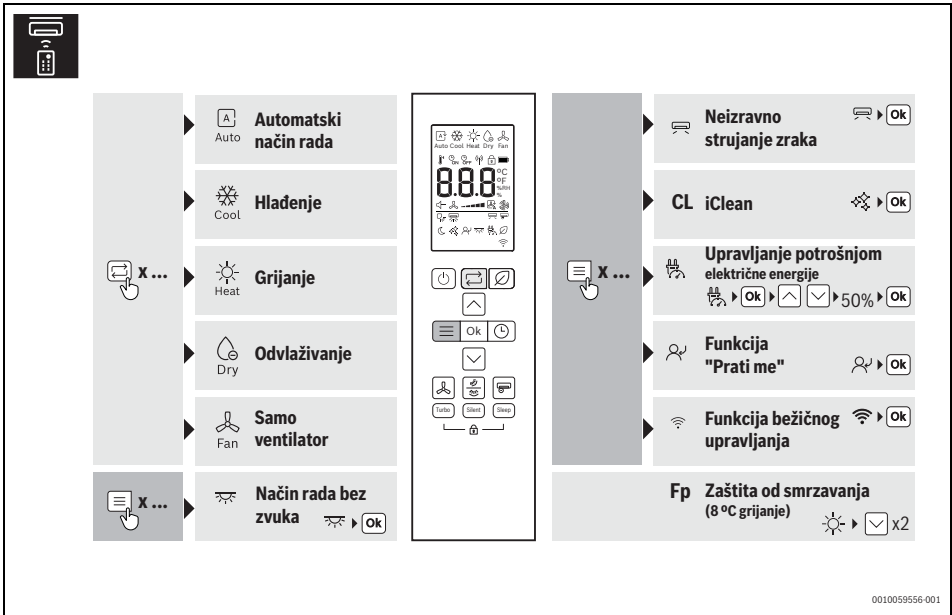

The diagram illustrates the remote control interface for a Bosch climate control system. It features a central display showing '8.8.8' and various icons for modes like Auto, Cool, Heat, Dry, and Fan. Surrounding the display are several function buttons and settings panels:

- Left Panel:**
 - Automatski način rada (Auto)
 - Hlađenje (Cool)
 - Grijanje (Heat)
 - Odvlaživanje (Dry)
 - Samo ventilator (Fan)
 - Način rada bez zvuka (Silent mode)
- Right Panel:**
 - Neizravno strujanje zraka (Indirect air flow)
 - CL iClean
 - Upravljanje potrošnjom električne energije (Energy saving)
 - Funkcija "Prati me" (Follow me)
 - Funkcija bežičnog upravljanja (Wireless control)
 - Fp Zaštita od smrzavanja (8 °C grijanje) (Anti-freeze protection)

0010059556-001

SI.65

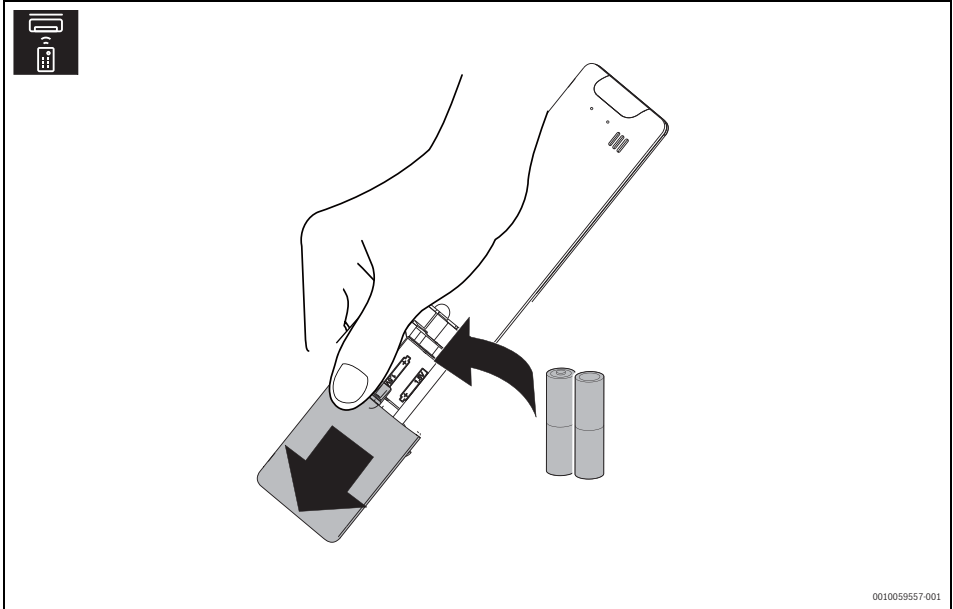

SI.66

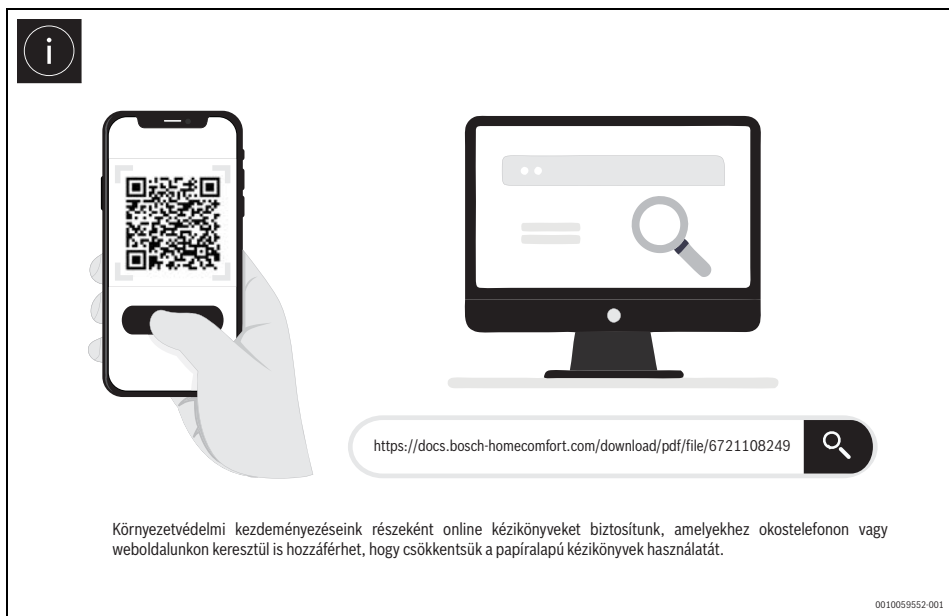

67. ábra

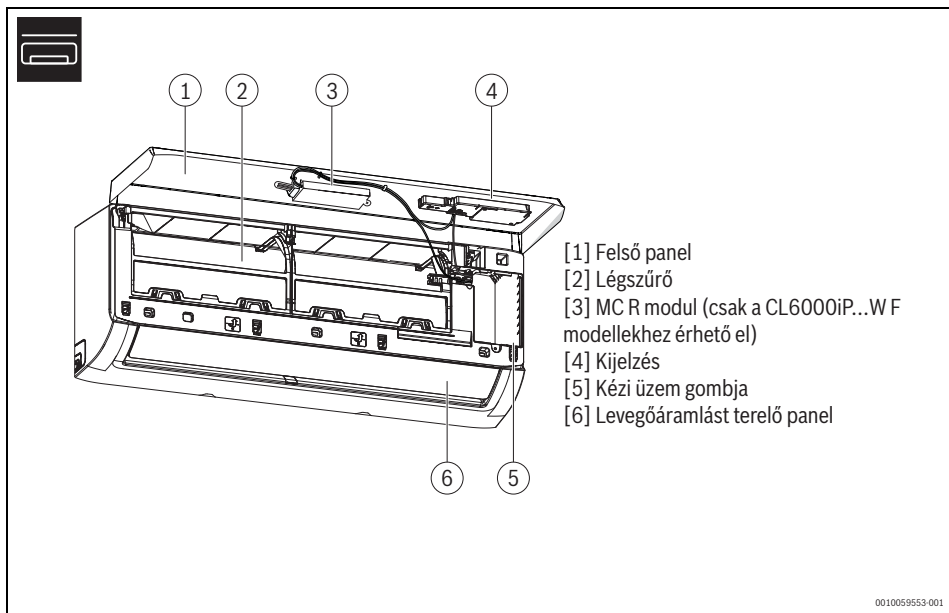

68. ábra

Szám Hőmérséklet kijelző	 WLAN kapcsolat aktív
BE Bizonyos funkciókkal megjelenítve, ha ezek be vannak kapcsolva. Jelzi, hogy a BE időzítő aktív, amikor a beltéri egység ki van kapcsolva.	OF Bizonyos funkciókkal megjelenítve, ha ezek ki vannak kapcsolva.
Ex, Px, Fx Hibakód (az "x" bármilyen számjegyet jelöl)	FP Fagyvédelem aktív: a beltéri egység a helyiség hőmérsékletét minimális 8°C
	CL Az öntisztító funkció aktív (iClean)

69. ábra

<ul style="list-style-type: none"> Be-/ kikapcsolás Üzem mód beállítás Mentés mód Ventilátor sebessége Lengés Szuper ionizátor Turbo üzemmód Alvás üzemmód Menü megerősítése 		<ul style="list-style-type: none"> Időzítő beállítása Postavljajte tajmera <ul style="list-style-type: none"> Nyomja meg a(z) vagy a(z) gombot a kívánt idő beállításához Nyomja meg a(z) vagy a(z) gombot a kívánt idő beállításához Állítsa be a 0,0 óra értéket Hőmérséklet növelése/ csökkenése Gyerekszár + = 5 másodperc
---	--	--

70. ábra

0010059555-001

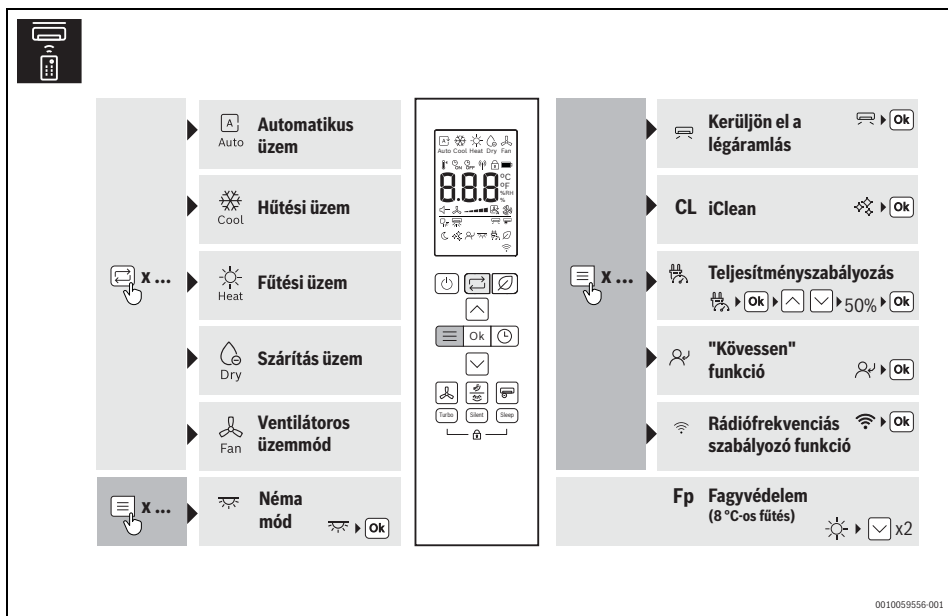

0010059556-001

71. ábra

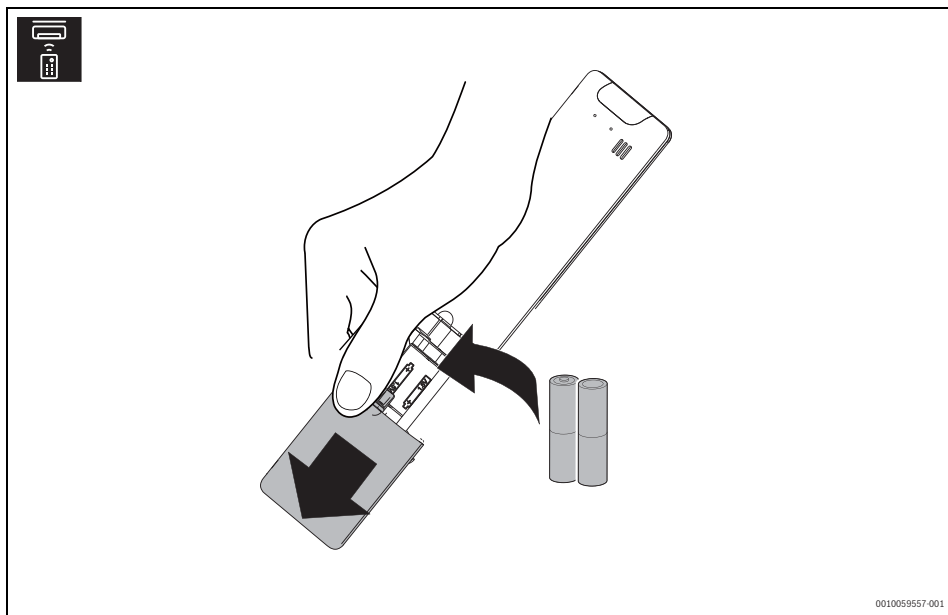

0010059557-001

72. ábra

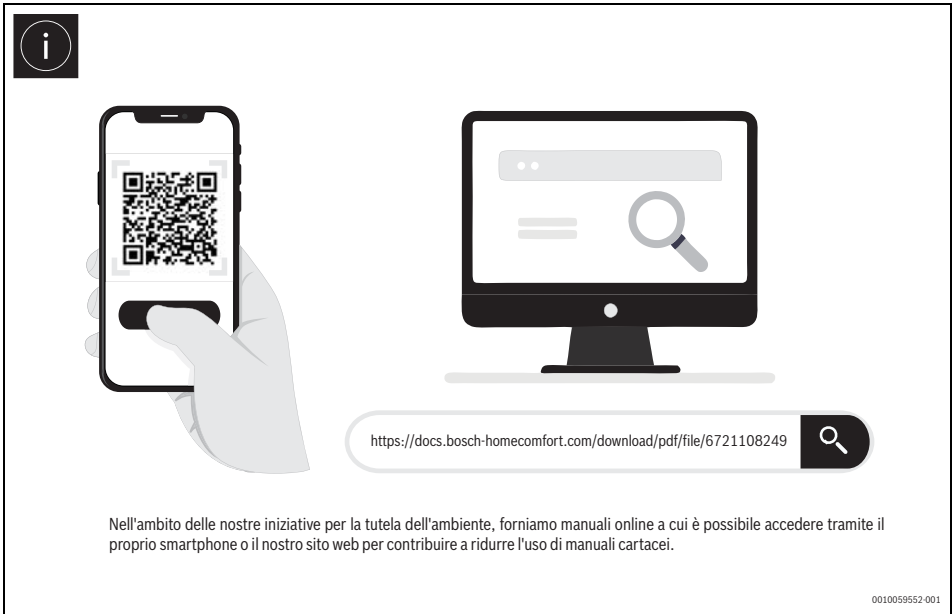

Fig. 73

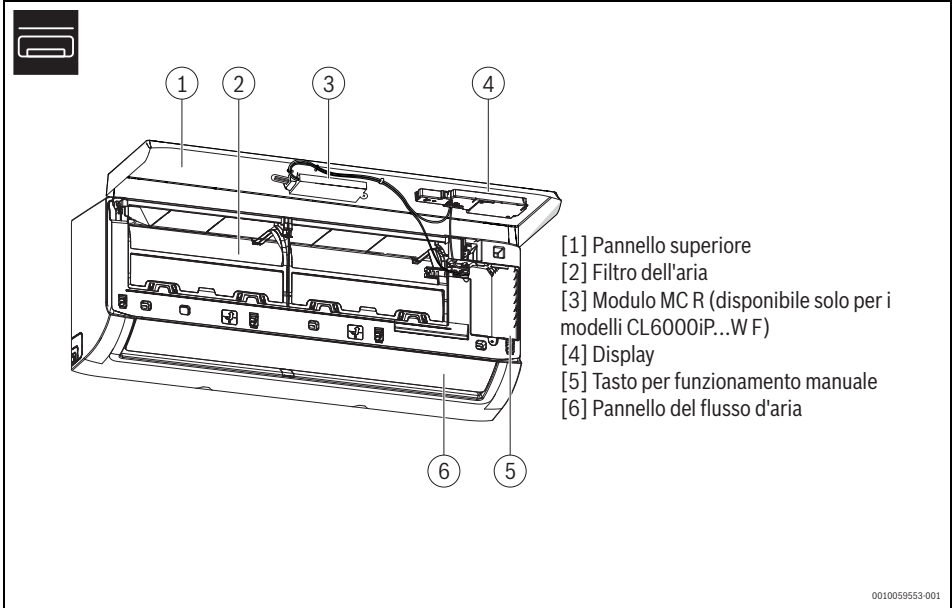

Fig. 74

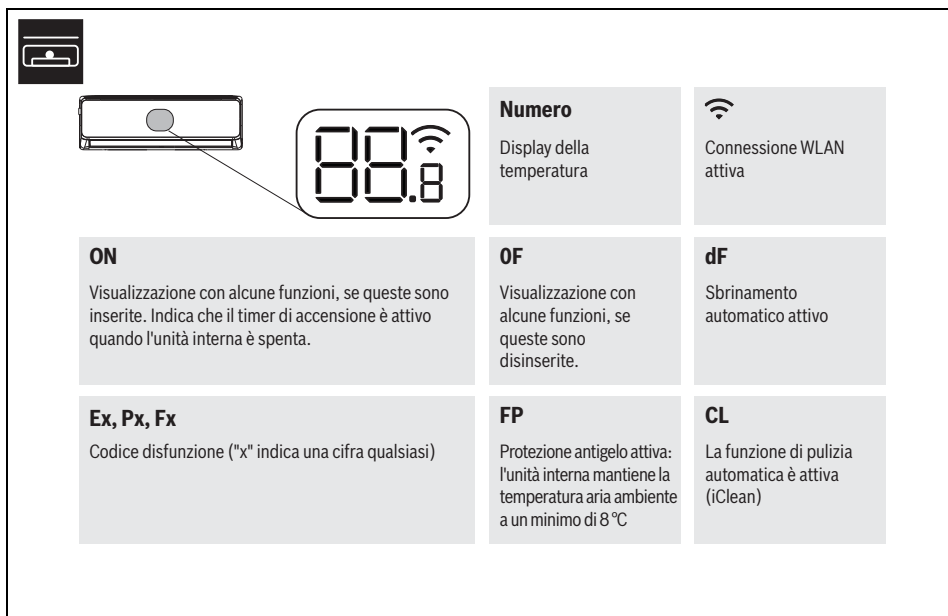

Fig. 75

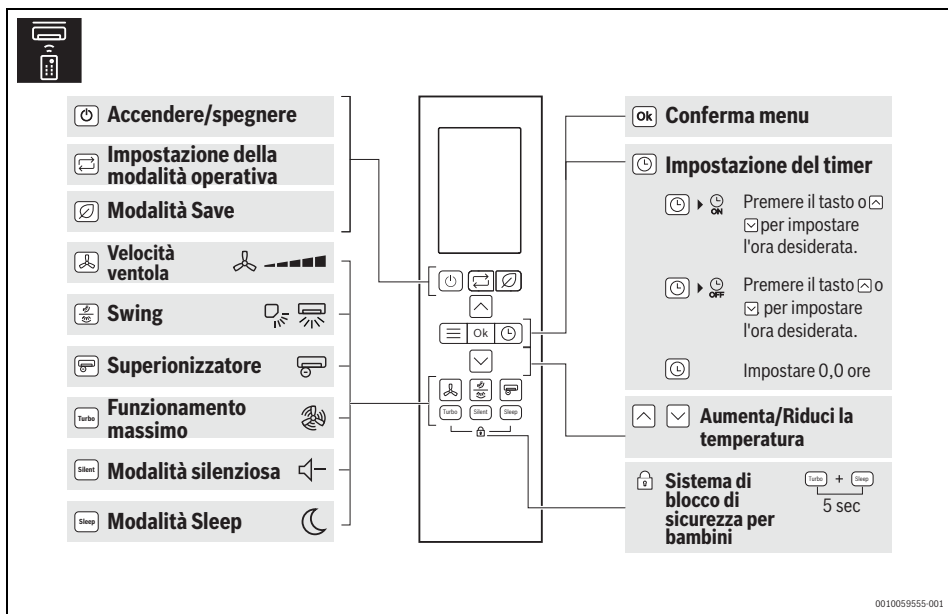

Fig. 76

0010059555-001

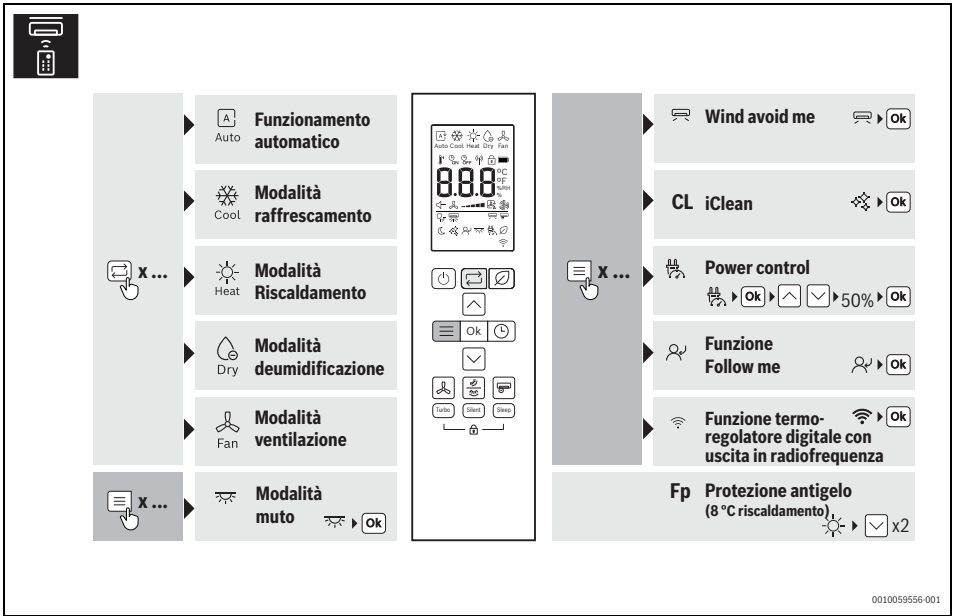

Fig. 77

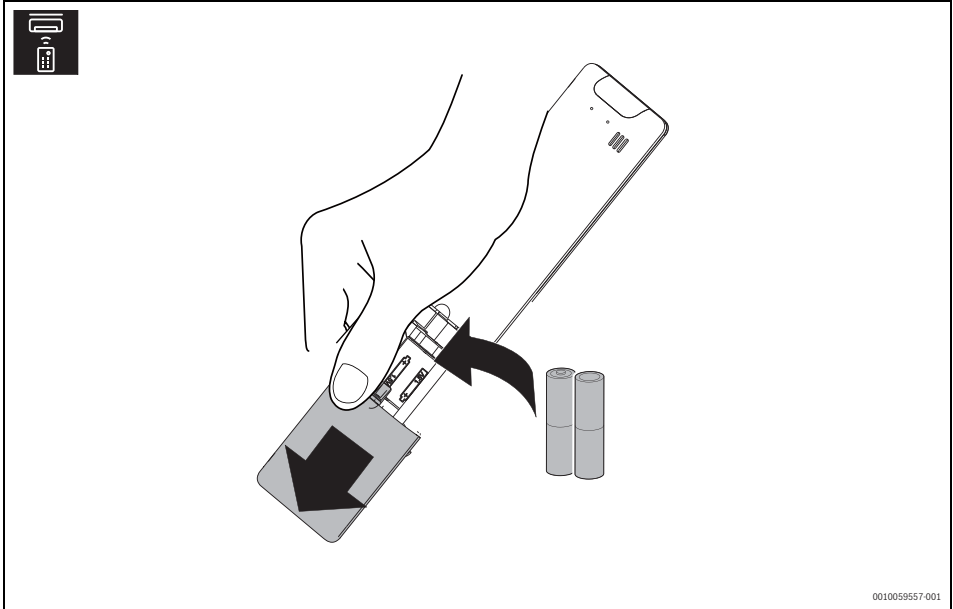
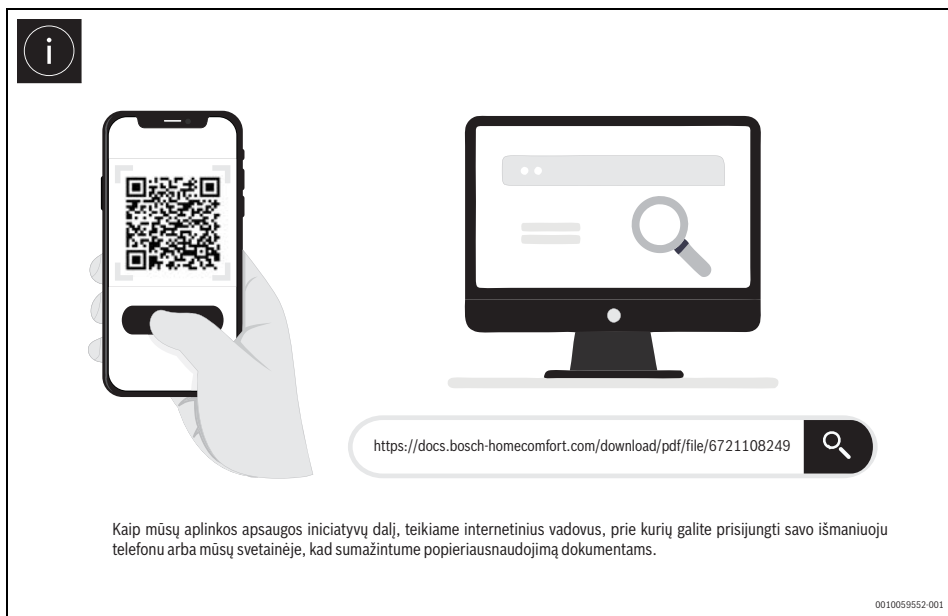
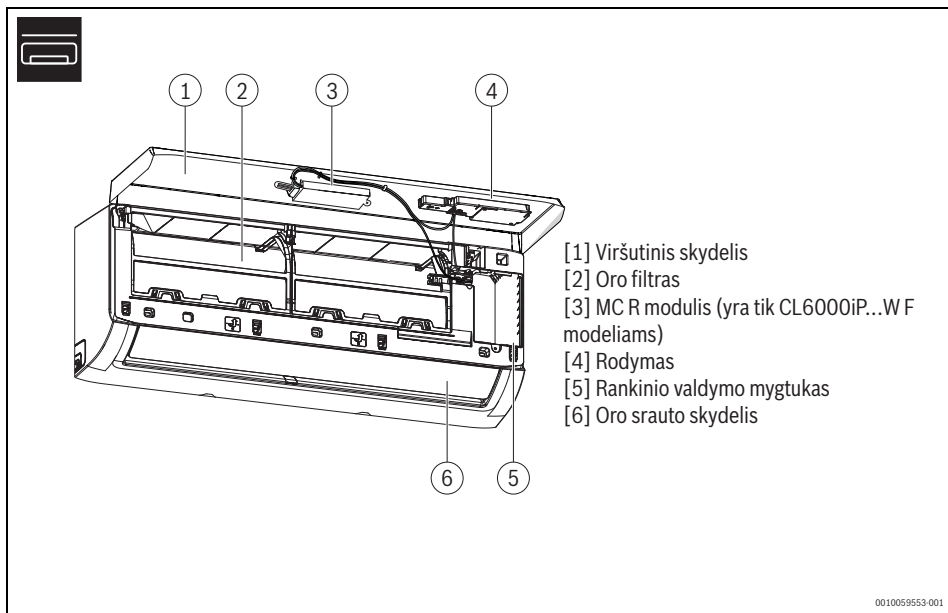

Fig. 78



Pav. 79



Pav. 80

IJUNGTA Rodoma su kai kuriomis funkcijomis, jei jos yra įjungtos. Nurodo, kad IJUNGIMO laikmatis yra aktyvus, kai vidinis blokas yra išjungtas.	Numeris Temperatūros ekranas	WLAN ryšys aktyvus
Ex, Px, Fx Trikties kodas ("x" reiškia bet kokį skaitmenį)	OF Rodoma su kai kuriomis funkcijomis, jei jos yra išjungtos.	dF Automatinis atitirpinimo režimas yra aktyvus
	FP Apsauga nuo užšalimo yra aktyvi: vidinis blokas palaiko bent 8 °C	CL Savaiminio išsivalymo funkcija yra aktyvi ("iClean")

Pav. 81

Ijungti / išjungti	Patvirtinimo meniu
Veikimo režimo sąranka	Laikmačio nustatymas
Taupymo režimas	Norėdami nustatyti norimą laiką, spauskite arba mygtuką
Ventiliatoriaus greitis	Norėdami nustatyti norimą laiką, spauskite arba mygtuką
Sukti	Nustatyti 0,0 val.
Super jonizatorius	Padidinti / sumažinti temperatūrą
"Turbo" režimas	Užraktas nuo vaikų
Tylusis režimas	5 sek.
Budėjimo režimas	

Pav. 82

0010059555-001

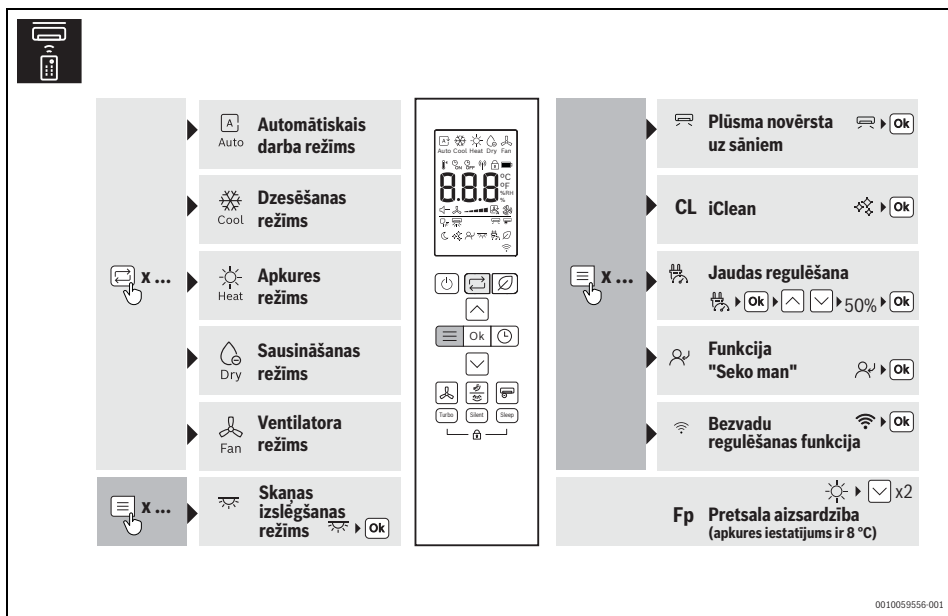

0010059556-001

Pav. 83

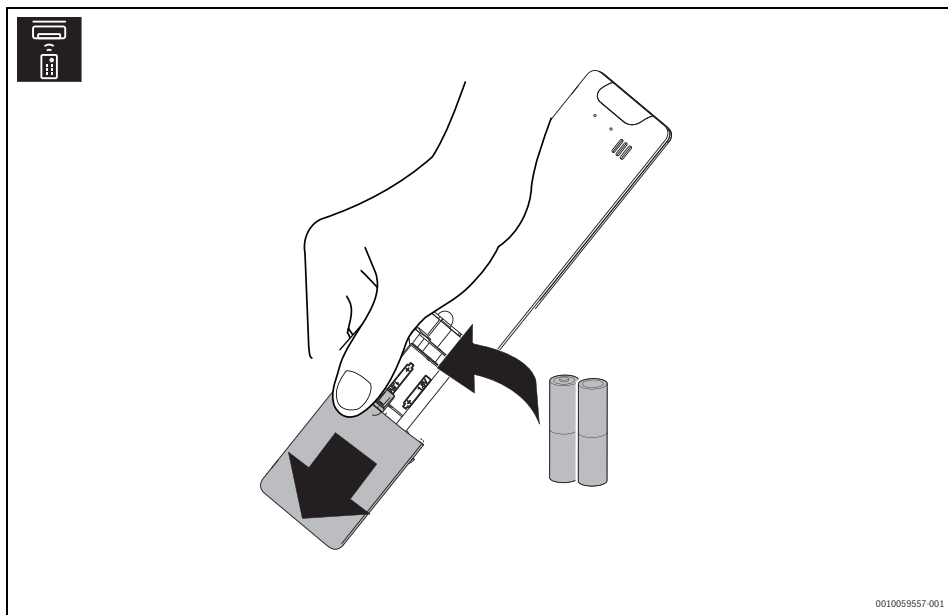

0010059557-001

Pav. 84

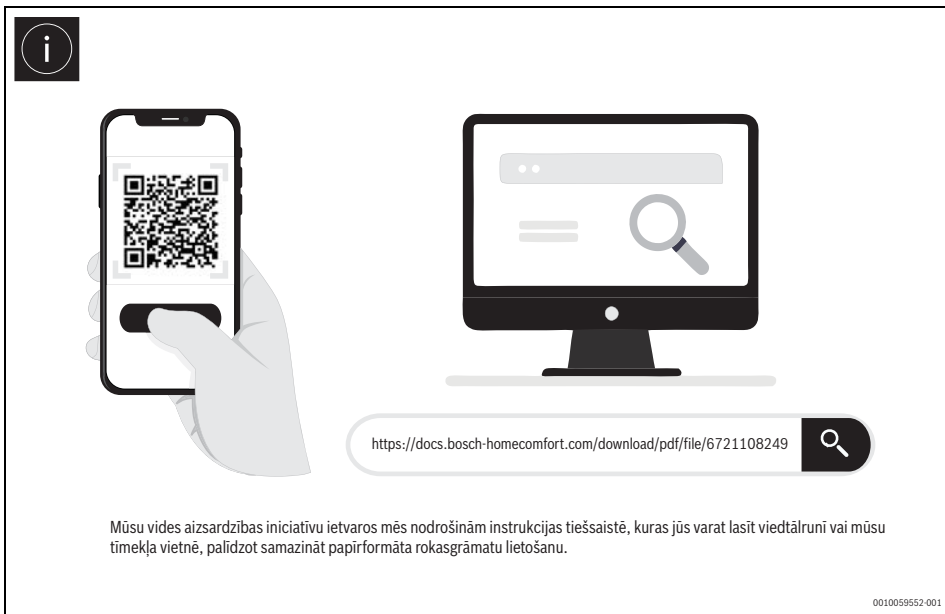

Att. 85

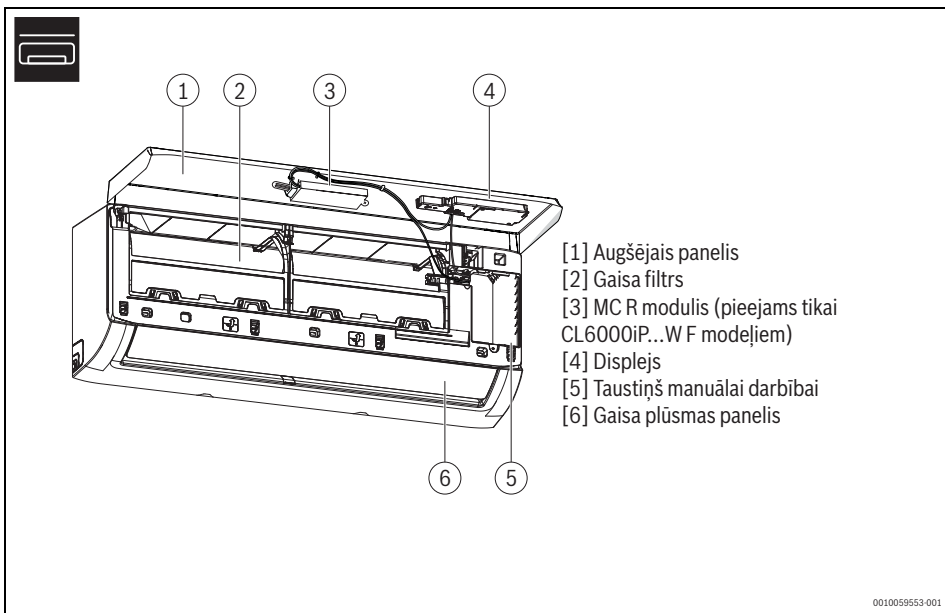



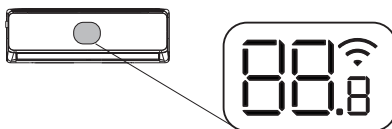





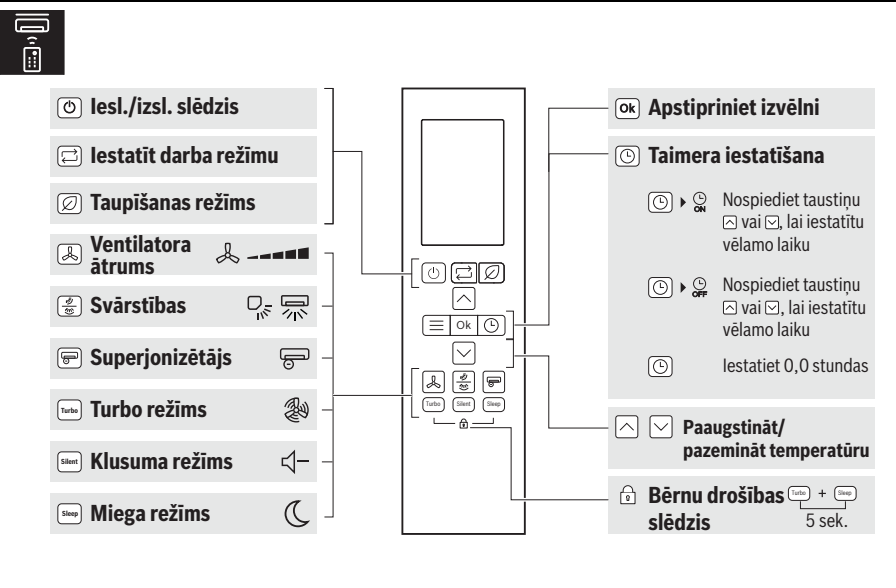











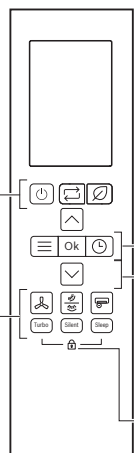





Att. 86



<p>IESL</p> <p>Tiek parādīts, izmantojot atsevišķas funkcijas, ja tās ir ieslēgtas. Norāda, ka ieslēgšanas taimeris ir aktīvs, kad iekšējais bloks ir izslēgts.</p>	<p>Numurs</p> <p>Temperatūras displejs</p>	<p></p> <p>WLAN savienojums ir aktīvs</p>
<p>Ex, Px, Fx</p> <p>Kļūmes kods ("x" atbilst jebkuram ciparam)</p>	<p>OF</p> <p>Tiek parādīts, izmantojot atsevišķas funkcijas, ja tās ir izslēgtas.</p>	<p>dF</p> <p>Aktivizēta automātiskā atkausēšana</p>
<p>FP</p> <p>Aktivizēta presala aizsardzība: iekšējais bloks uztur telpas temperatūru ne mazāku par 8 °C</p>	<p>CL</p> <p>Aktivizēta automātiskās tīrīšanas funkcija ("iClean")</p>	

Att. 87



<ul style="list-style-type: none">  iesl./izsl. slēdzis  iestatīt darba režīmu  Taupīšanas režīms  Ventilatora ātrums  Svārstības  Superjonizētājs  Turbo režīms  Klusuma režīms  Miega režīms 		<ul style="list-style-type: none">  Apstipriniet izvēlni  Taimera iestatīšana <ul style="list-style-type: none">   Nospiediet taustiņu  vai , lai iestatītu vēlamo laiku   Nospiediet taustiņu  vai , lai iestatītu vēlamo laiku  Iestatiet 0,0 stundas   Paaugstināt/ pazemināt temperatūru  Bērnu drošības slēdzis  +  5 sek.
--	--	---

0010059555-001

Att. 88

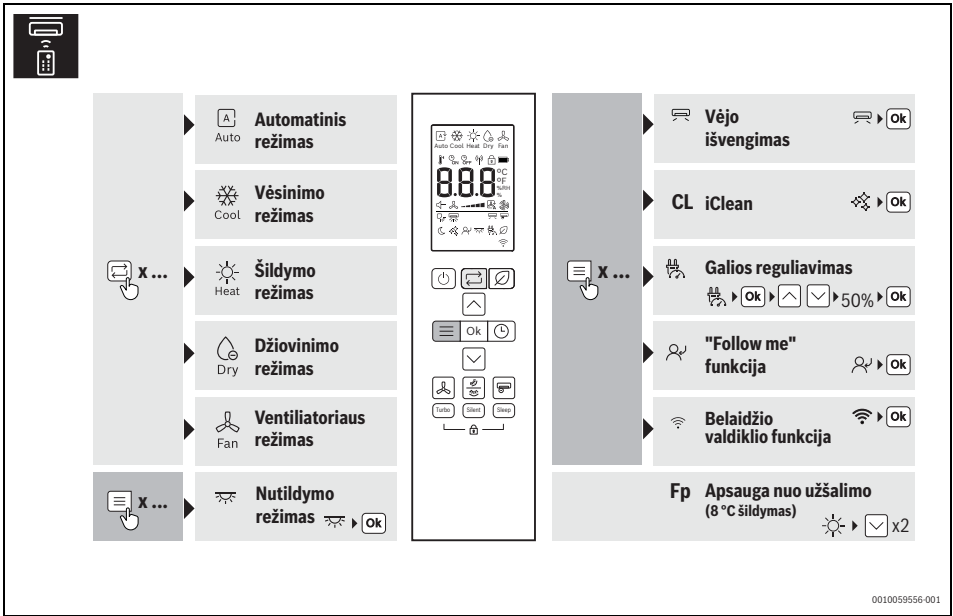

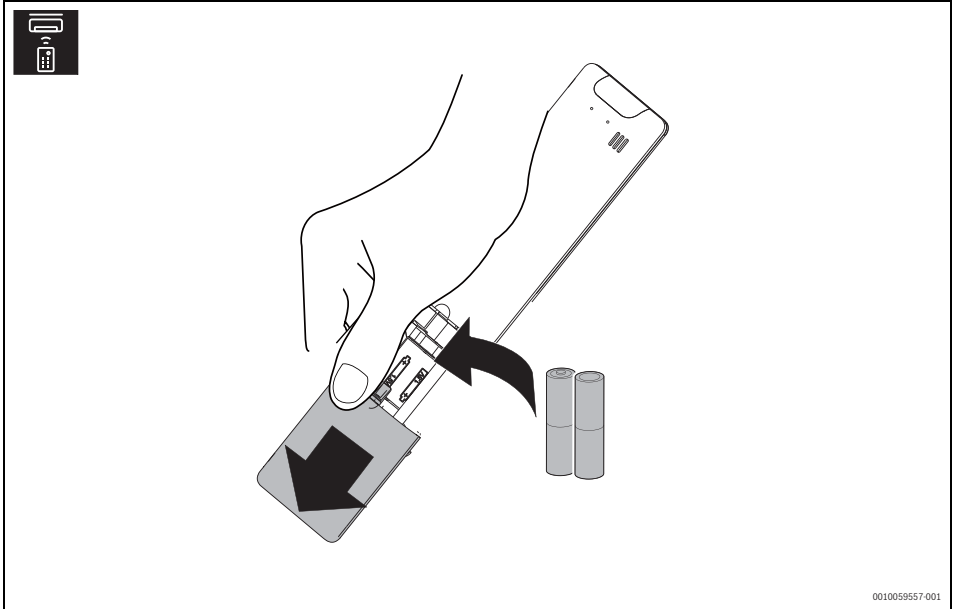

Att. 89



Att. 90

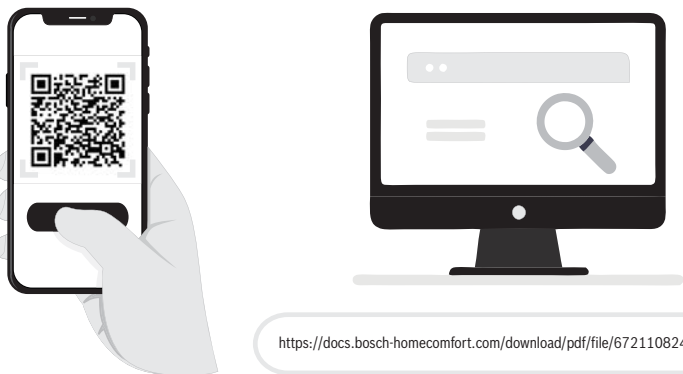



<https://docs.bosch-homecomfort.com/download/pdf/file/6721108249> 

Како дел од нашите иницијативи за заштита на животната средина, нудиме онлајн прирачници до кои може да пристапите преку вашиот паметен телефон или нашиот веб-сајт заради намалување на употребата на хартија за прирачниците.

0010059552-001

Сл. 91



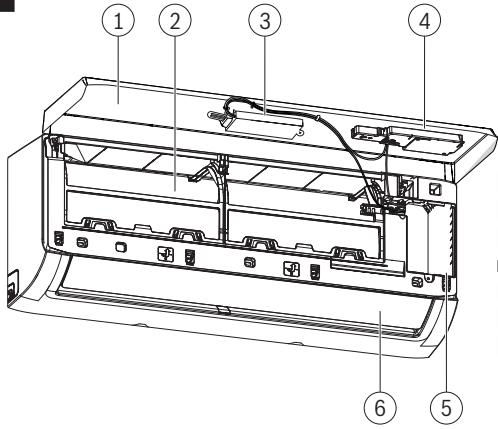

[1] Горен панел
[2] Филтер за воздух
[3] MC R MODULE (достапен само за модели CL6000iP ... WF)
[4] Приказ
[5] Копче за рачно ракување
[6] Панел за проток на воздух

0010059553-001

Сл. 92

<p>ВКЛ</p> <p>Се прикажува со некои функции, доколку тие се вклучени. Покажува дека тајмерот за вклучување е активен кога внатрешната единица е исклучена.</p>	<p>Број</p> <p>Приказ на температура</p>	<p></p> <p>WLAN врската е активна</p>
<p>Ех, Рх, Fx</p> <p>Код за дефект ("x" се однесува на која било цифра)</p>	<p>OF</p> <p>Се прикажува со некои функции, доколку тие се исклучени.</p>	<p>dF</p> <p>Активно е автоматското одмрзнување</p>
	<p>FP</p> <p>Активна заштита од мраз: внатрешната единица ја одржува собната температура на минимум 8 °C</p>	<p>CL</p> <p>Функцијата за самоочиштење е активна (iClean)</p>

Сл. 93

<p> Вклучување/исклучување</p>	<p> Мени за потврдување</p>
<p> Поставување режим на работа</p>	<p> Поставување тајмер</p> <p> Притиснете го копчето или за да се поставиме посакуваното време</p> <p> Притиснете го копчето или за да се поставиме посакуваното време</p> <p> Поставете 0,0 часа</p>
<p> Режим на зачувување</p>	<p> Зголемување/намалување на температурата</p>
<p> Брзина на вентилатор</p>	<p> Блокада за деца</p> <p> + 5 секунди</p>
<p> Нишање</p>	
<p> Супер јонизатор</p>	
<p> Турбо режим</p>	
<p> Тивок режим</p>	
<p> Режим на спиење</p>	

0010059555-001

Сл. 94

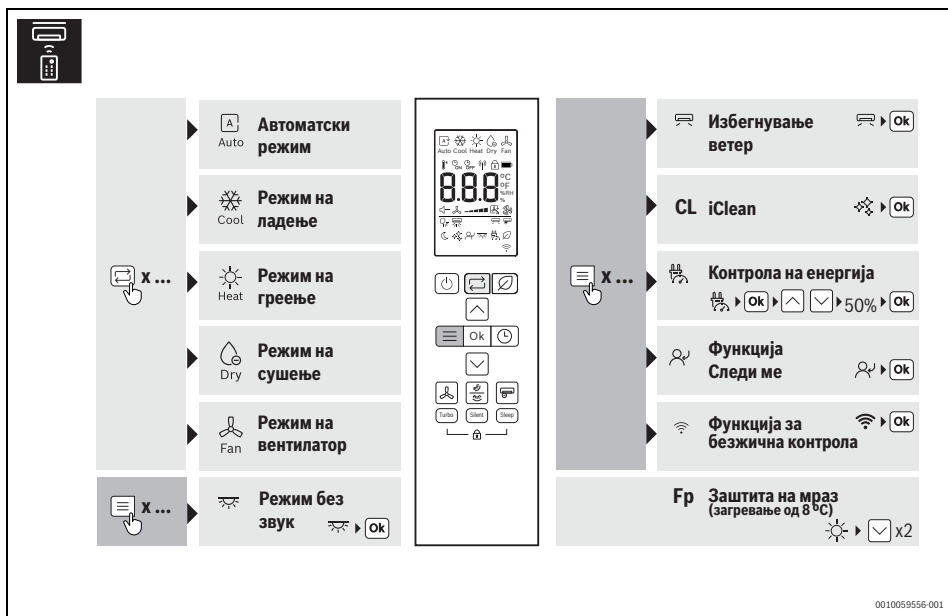

0010059556-001

Сл. 95

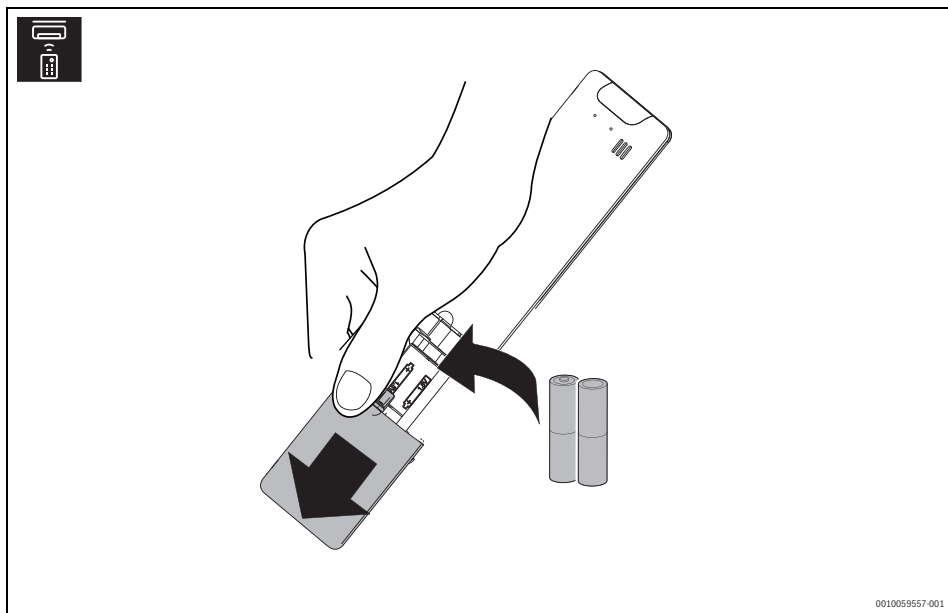

0010059557-001

Сл. 96

i

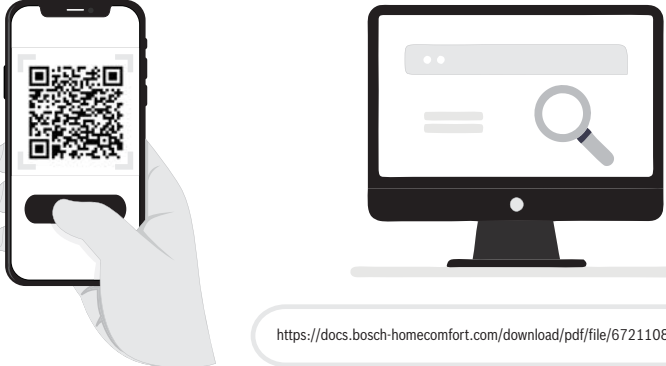

<https://docs.bosch-homecomfort.com/download/pdf/file/6721108249>

Als onderdeel van onze initiatieven voor milieubescherming bieden wij online handleidingen aan die u via uw smartphone of via onze website kunt raadplegen. Zo helpen wij het gebruik van papieren handleidingen te verminderen.

0010059552.001

Afb. 97



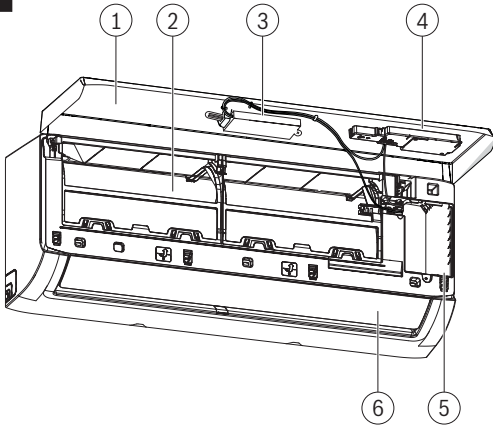

[1] Bovenste paneel
 [2] Luchtfilter
 [3] MC R-module (alleen beschikbaar voor CL6000iP...W F-modellen)
 [4] Weergave
 [5] Toets voor handbediening
 [6] Luchtstrooppaneel

0010059553.001

Afb. 98

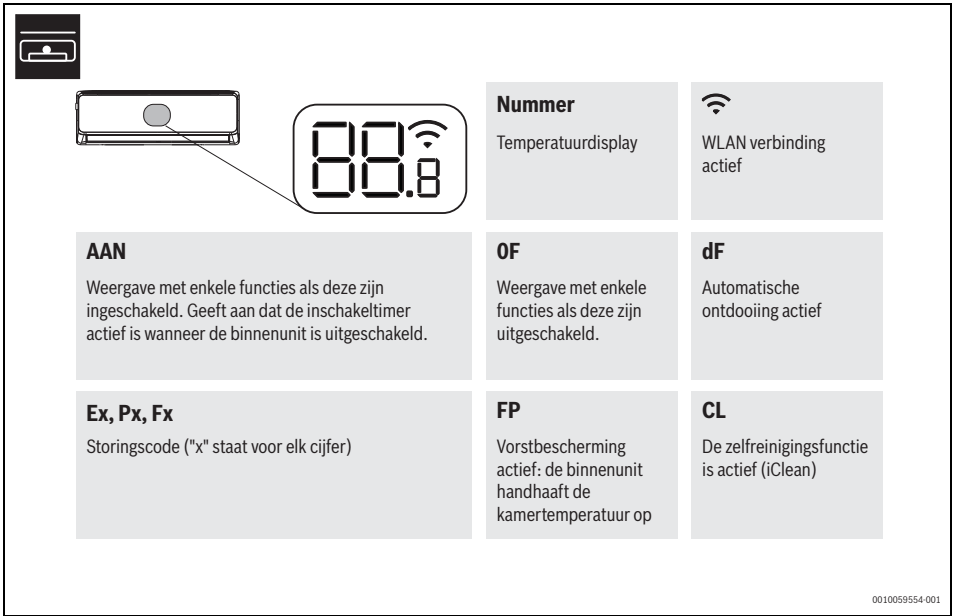

Afb. 99

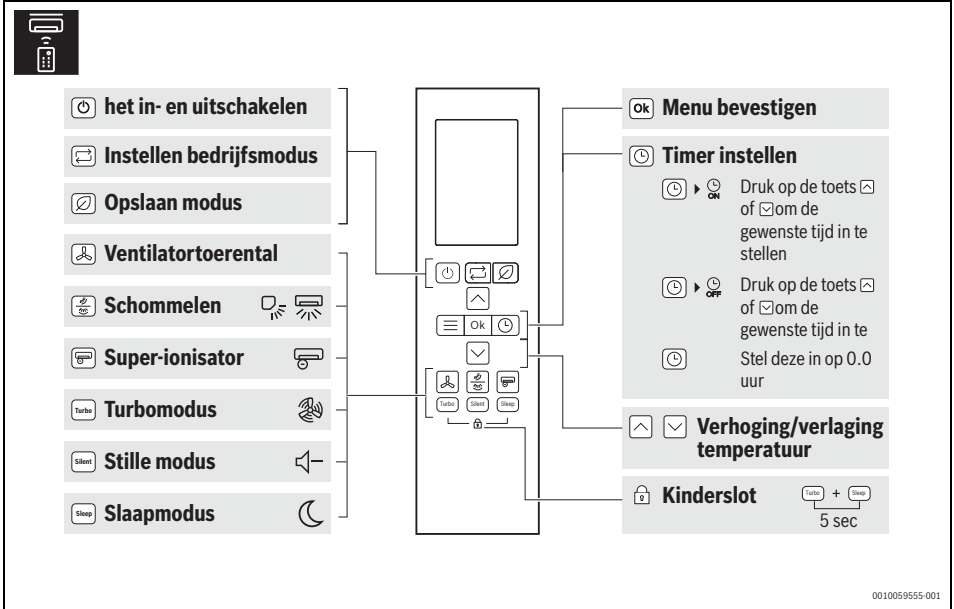

Afb. 100

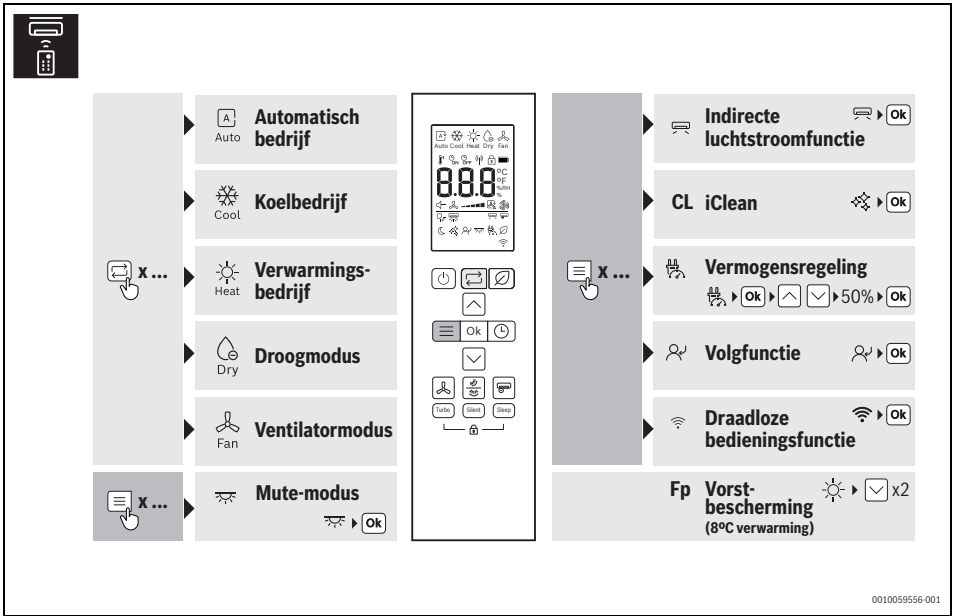

Afb. 101

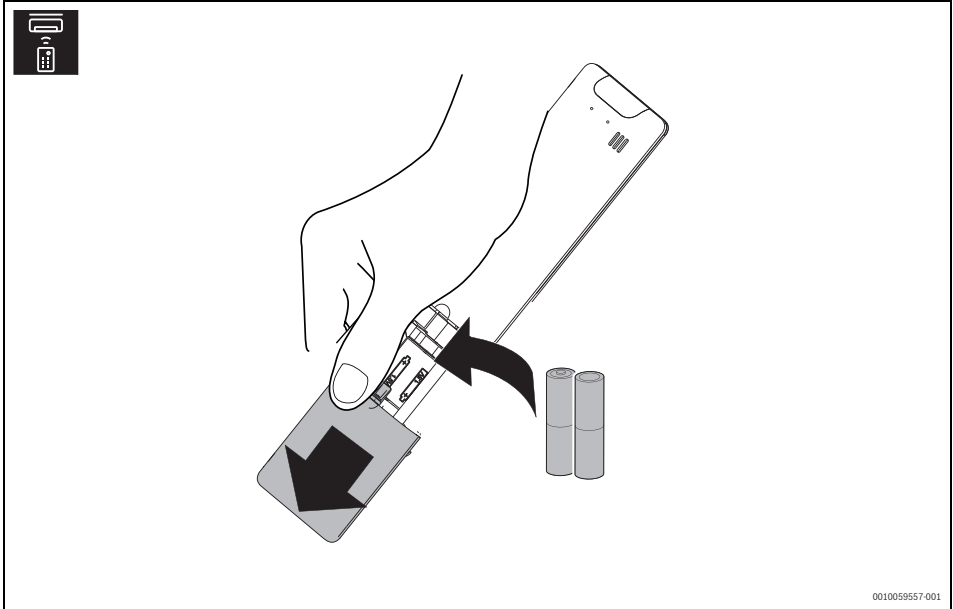

Afb. 102

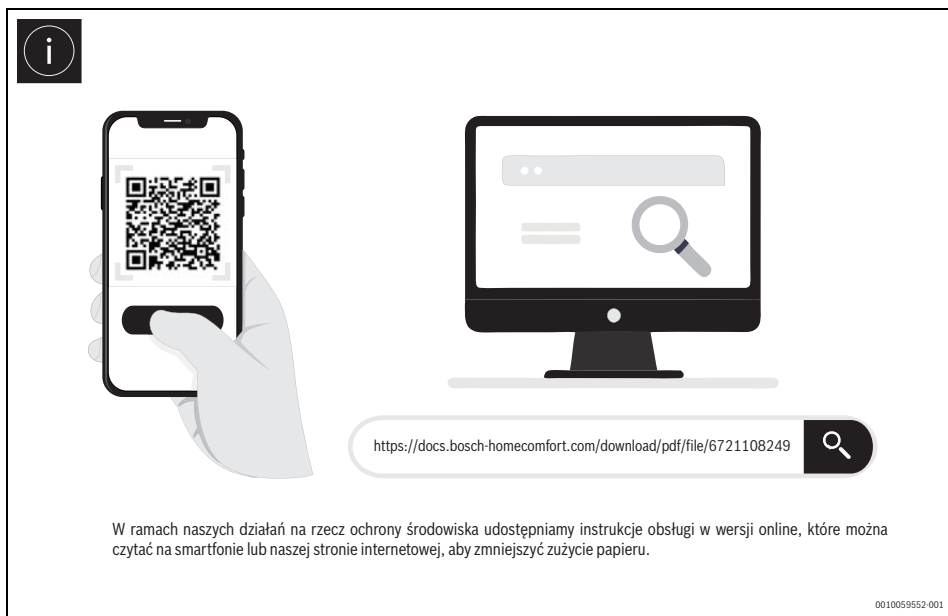

Rys. 103

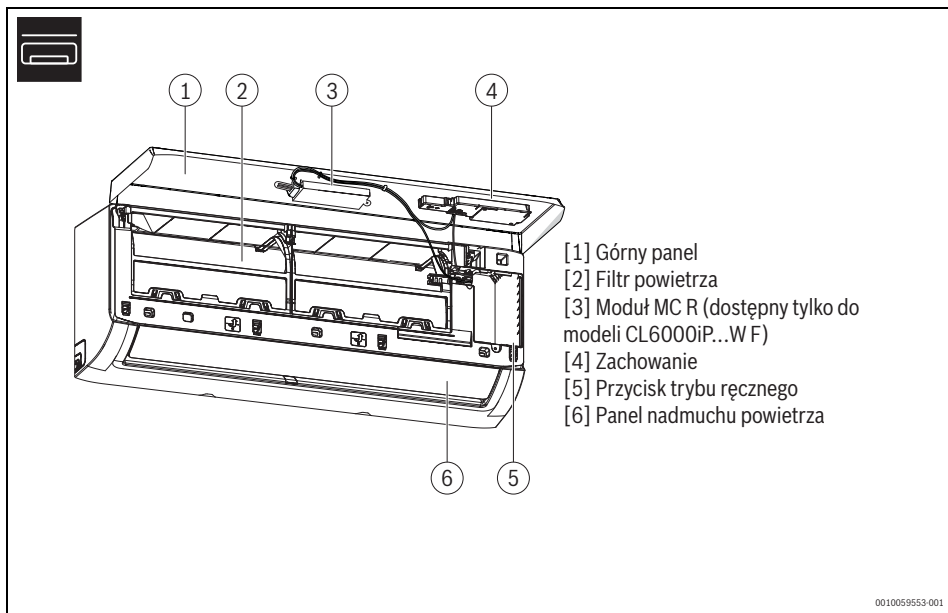

Rys. 104

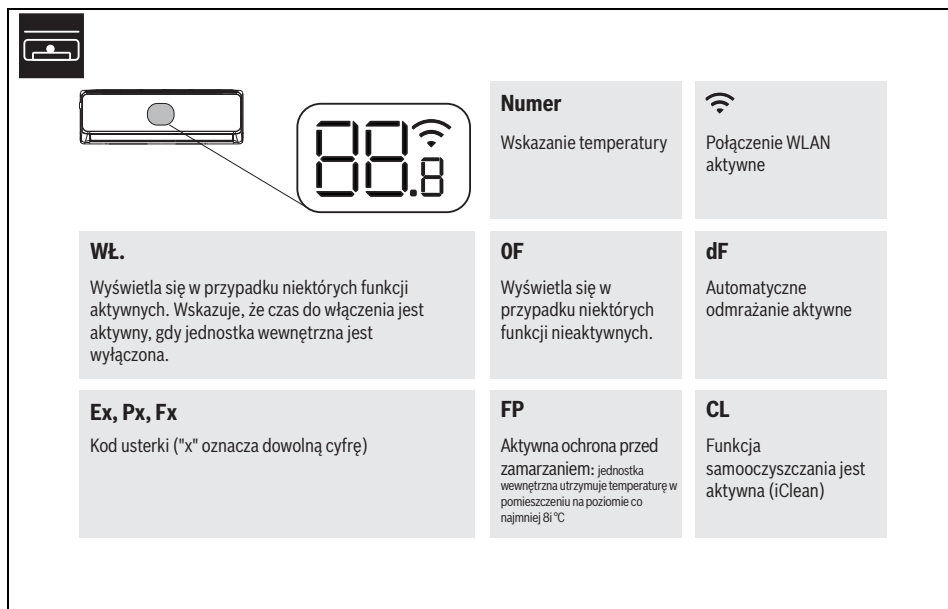

Rys. 105

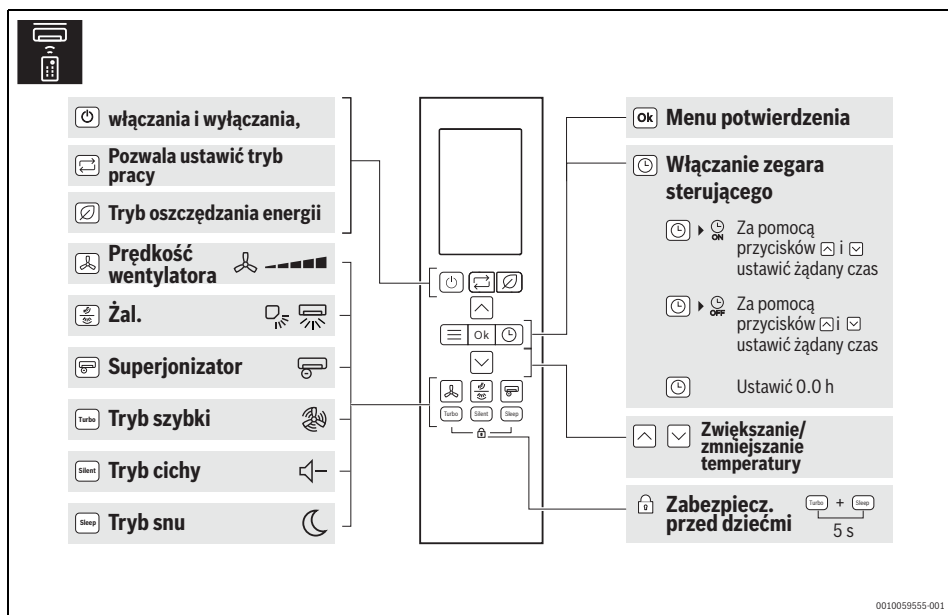

0010059555-001

Rys. 106

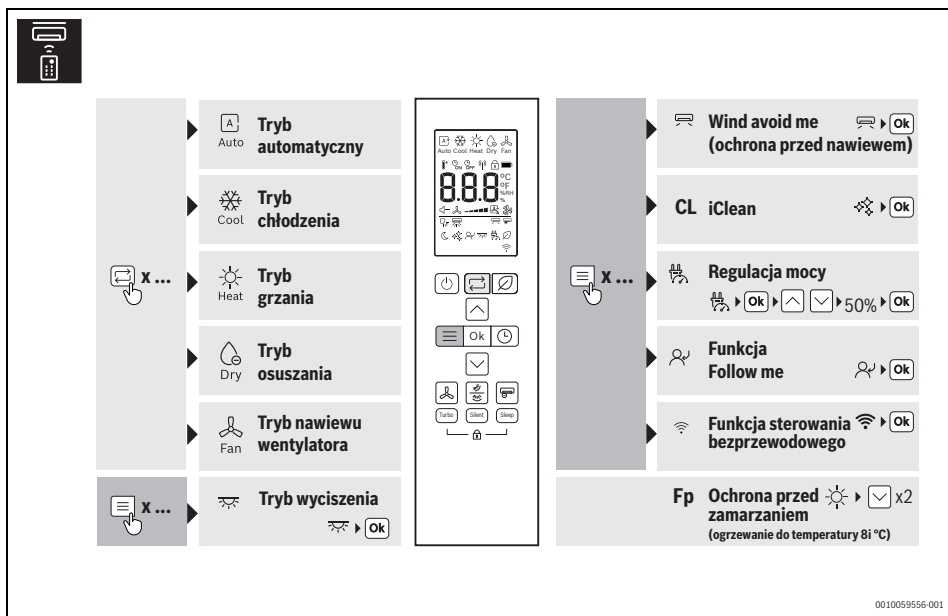

Rys. 107

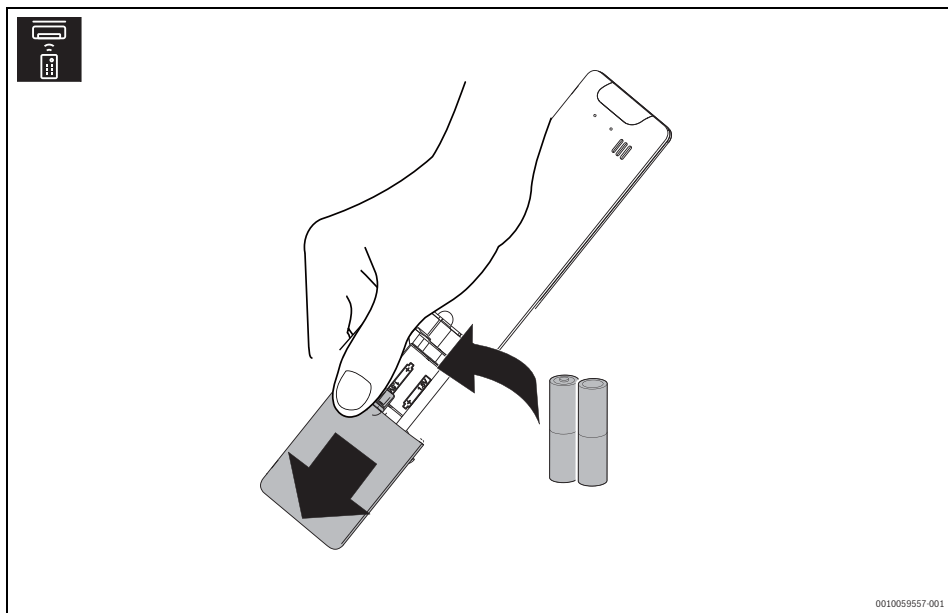

Rys. 108



Fig. 109

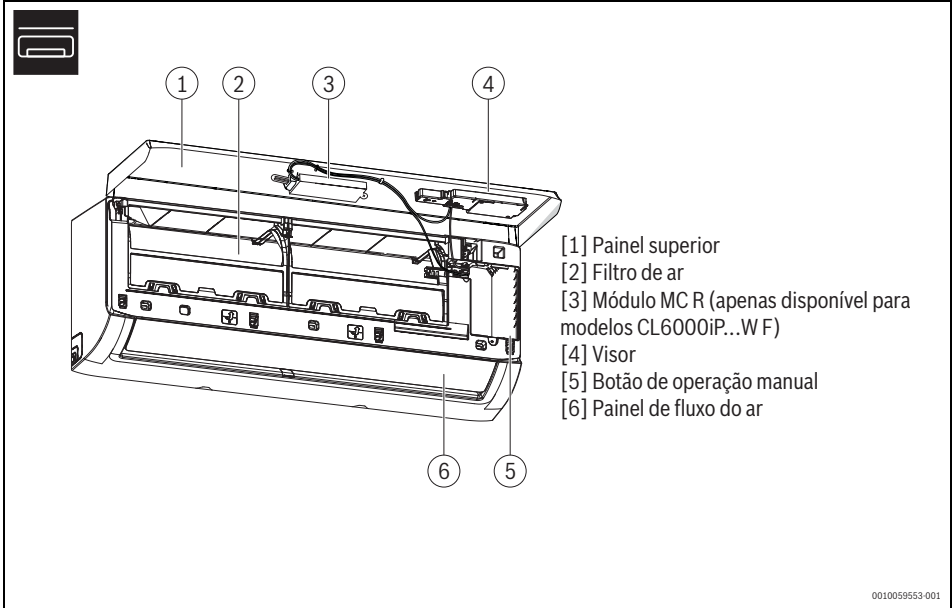

Fig. 110

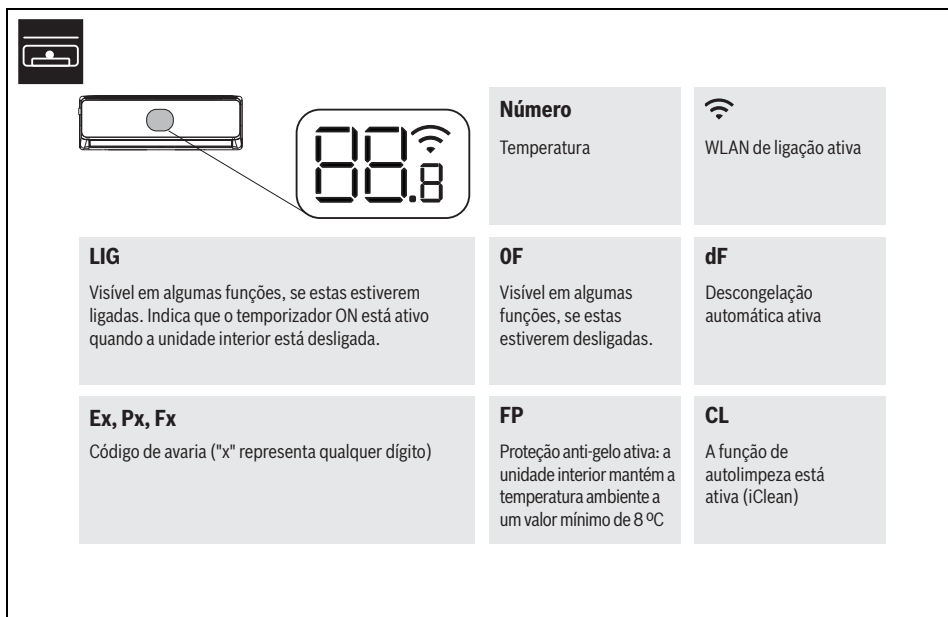

Fig. 111

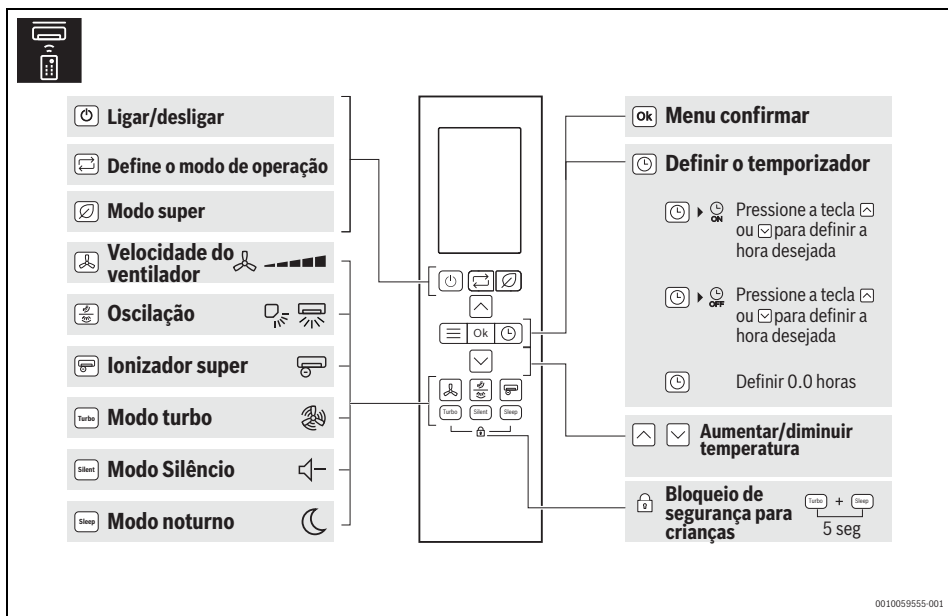
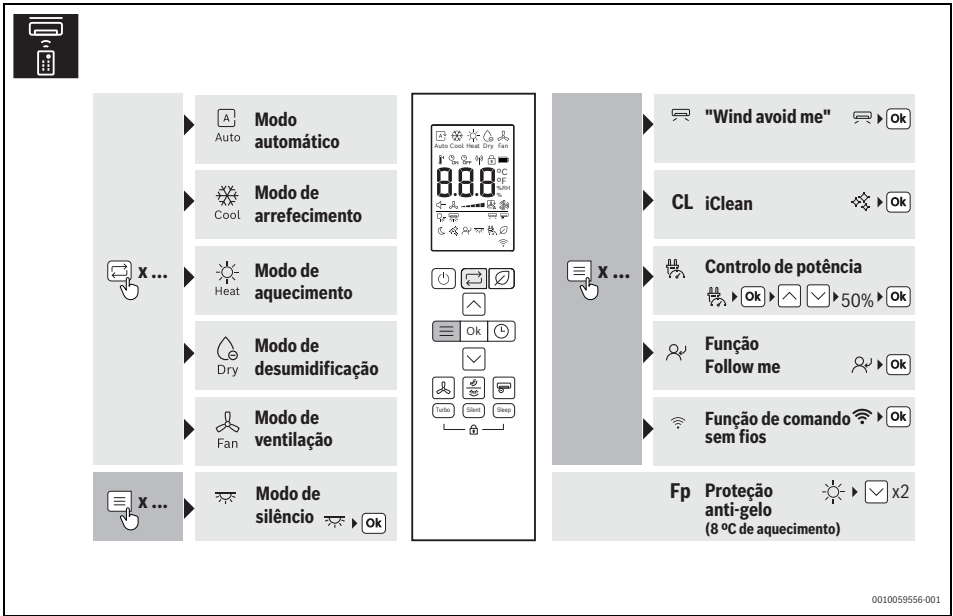

Fig. 112

0010059555-001



0010059556-001

Fig. 113

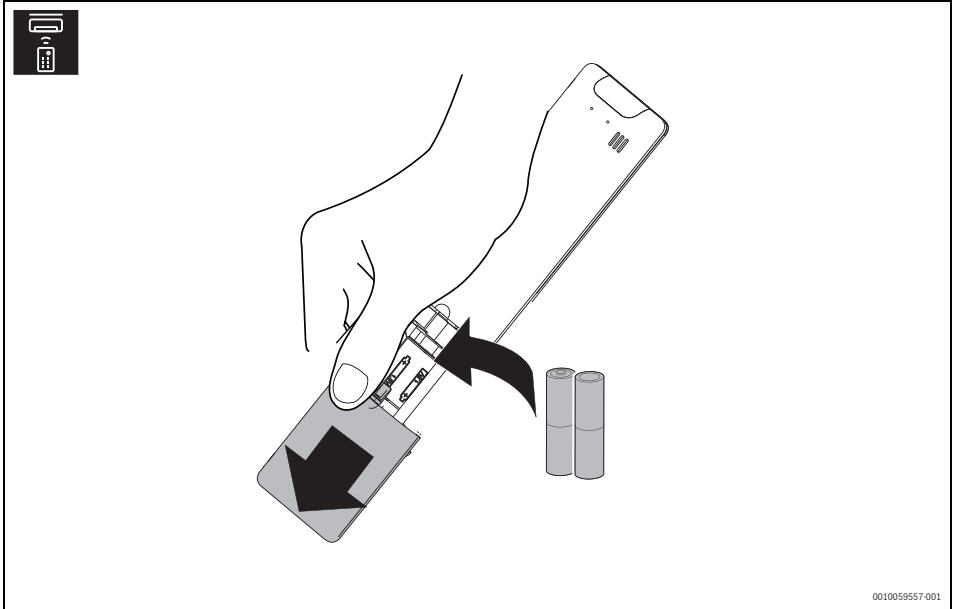

0010059557-001

Fig. 114



Fig. 115

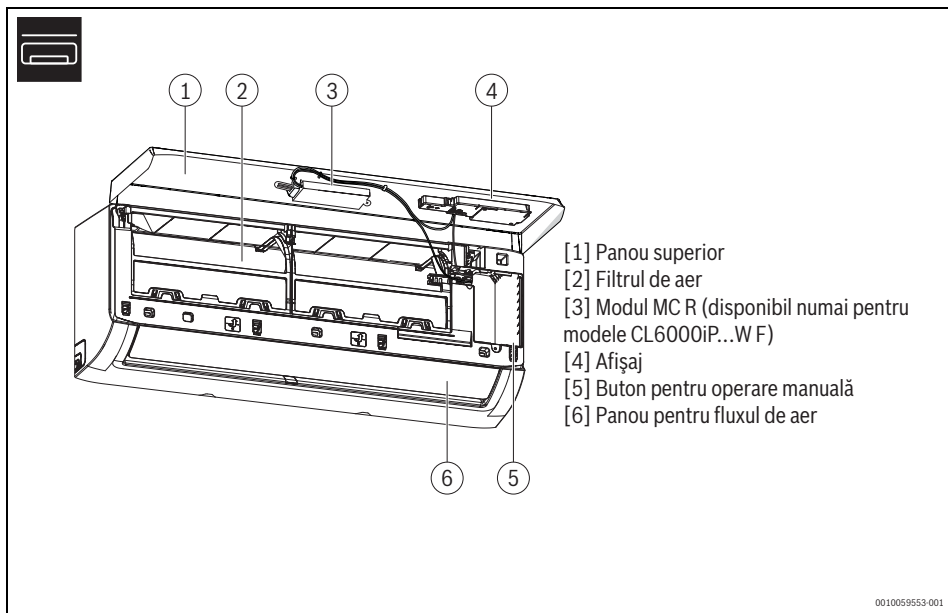

Fig. 116

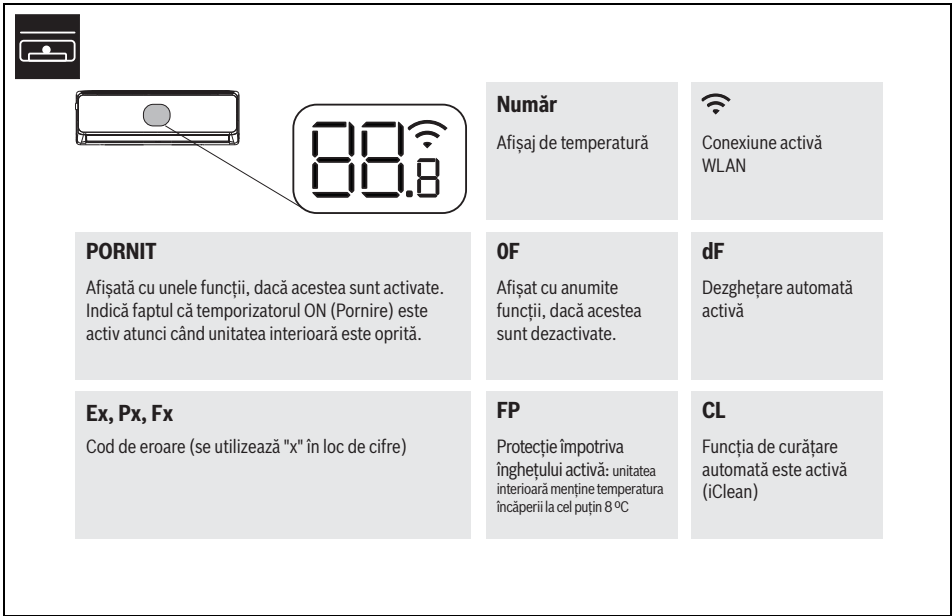

Fig. 117

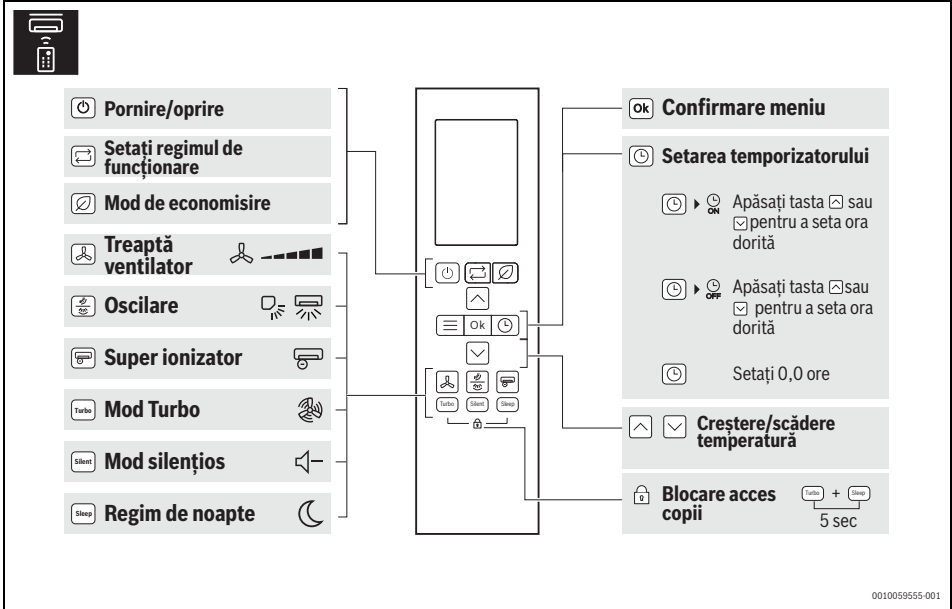
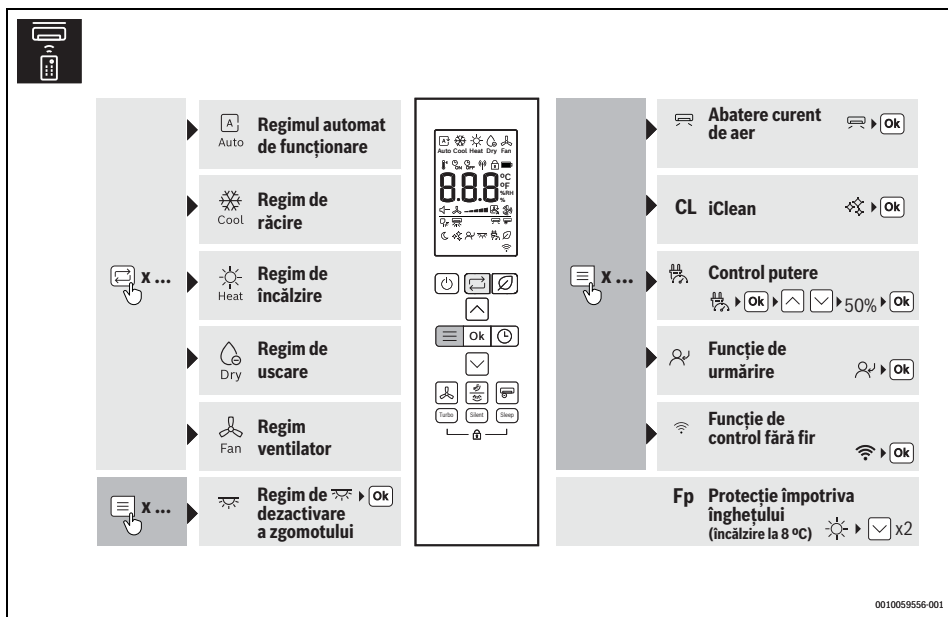
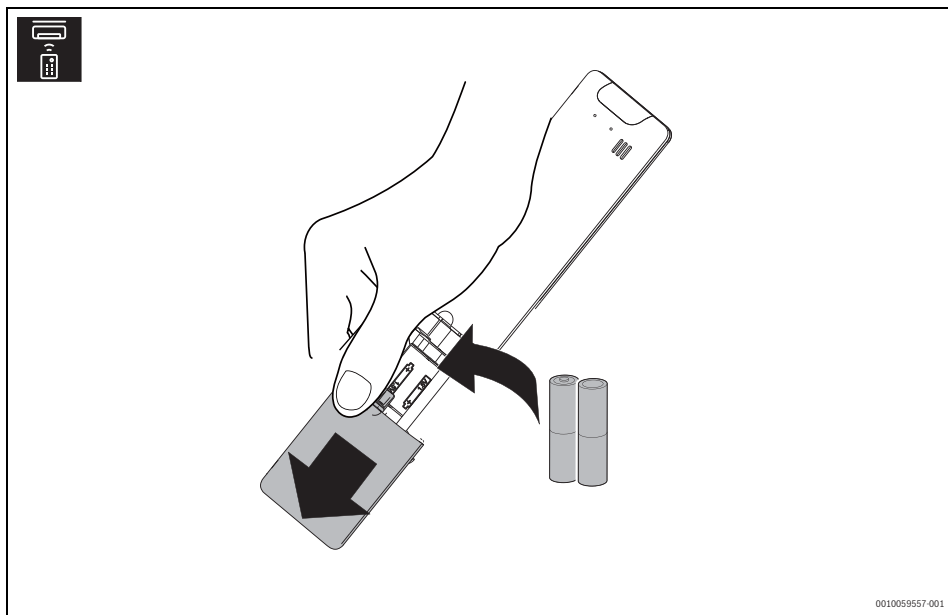

Fig. 118



0010059556-001

Fig. 119



0010059557-001

Fig. 120

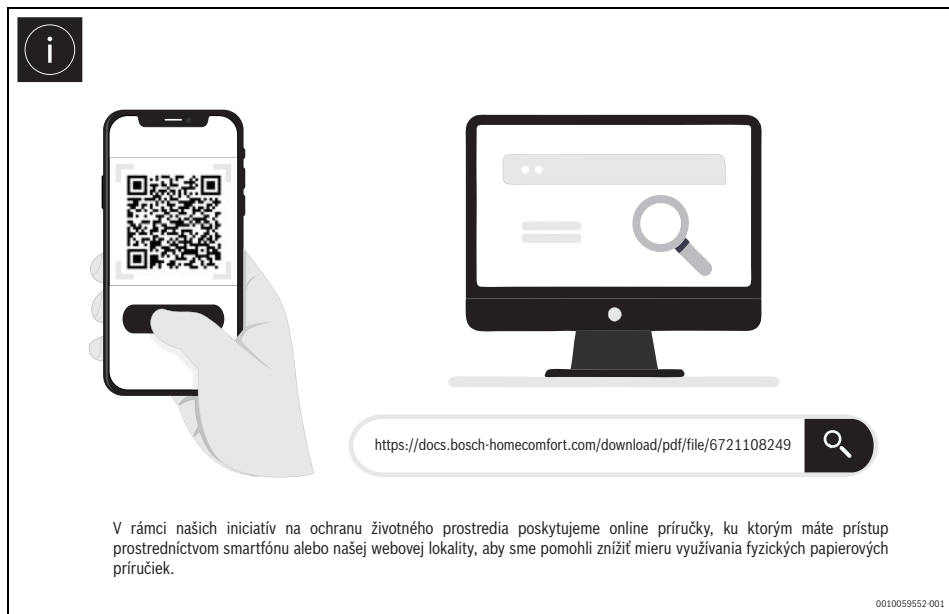

Obr. 121

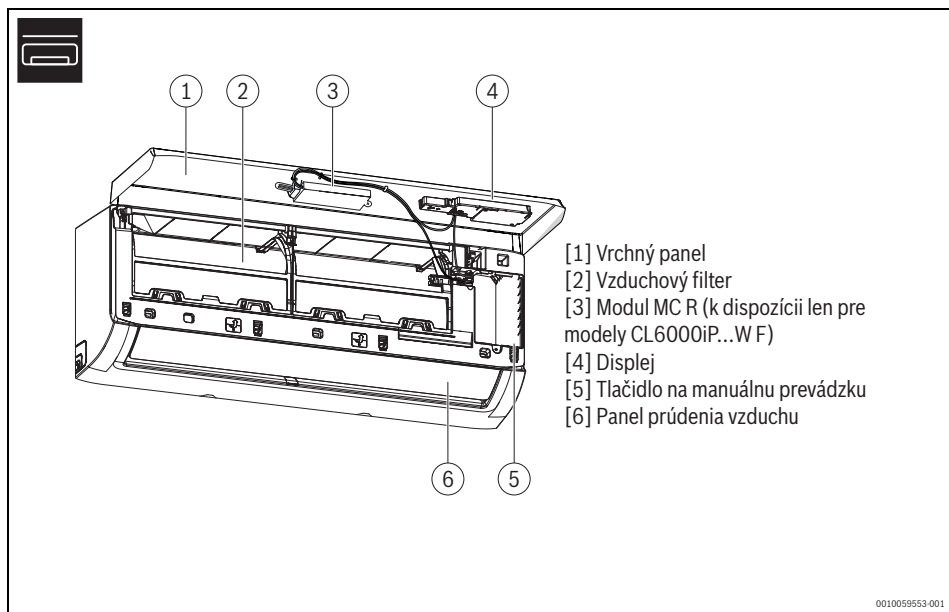

Obr. 122

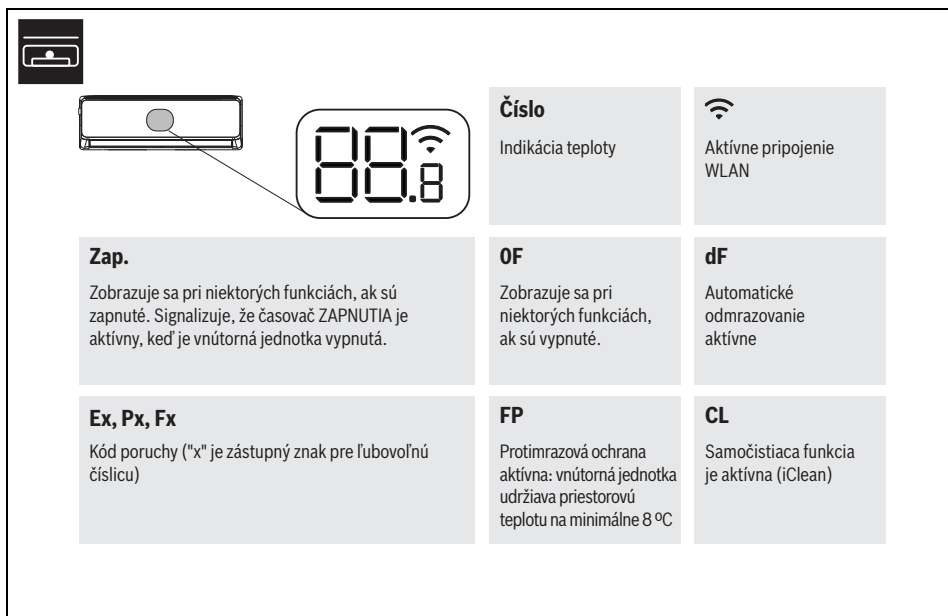

Obr. 123

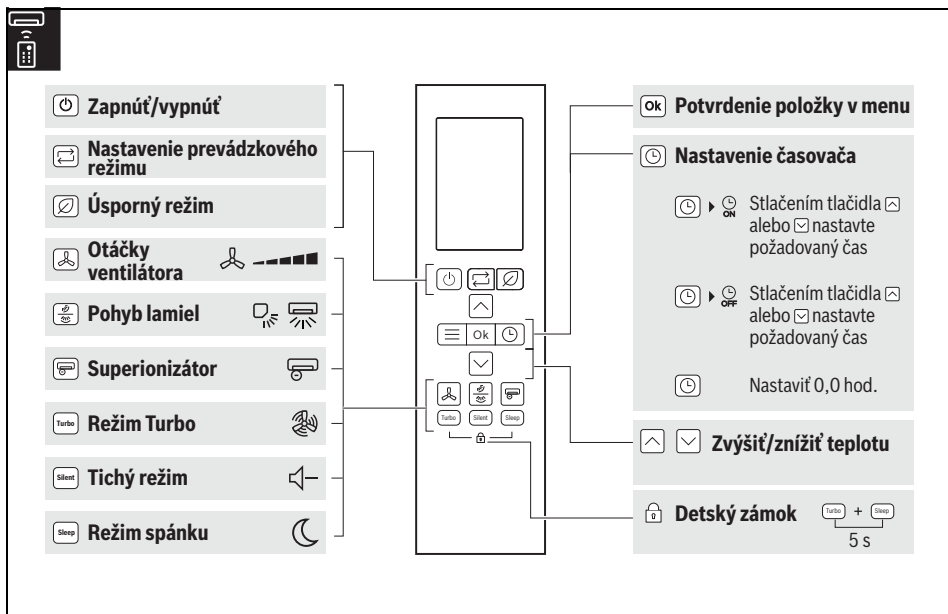

Obr. 124

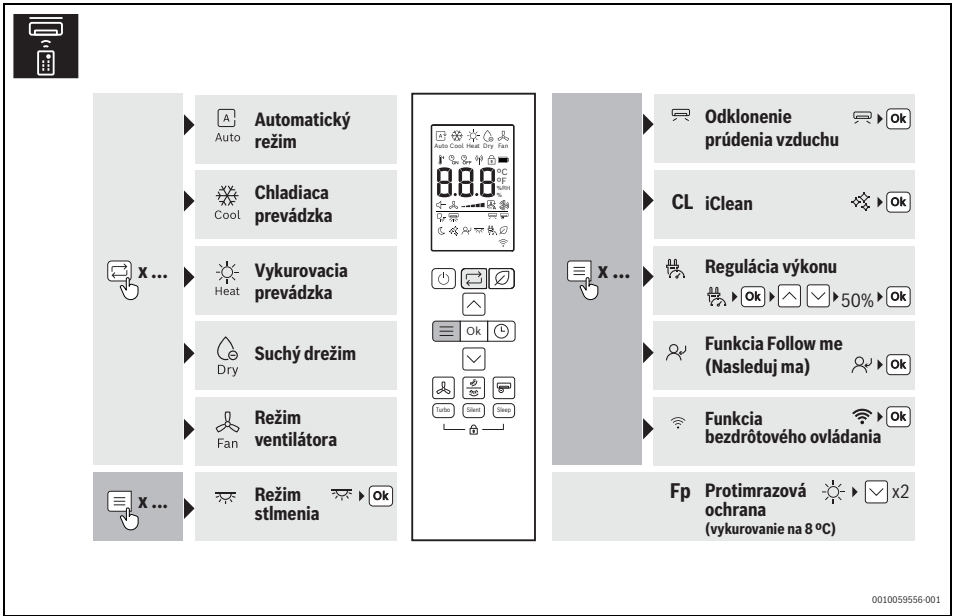

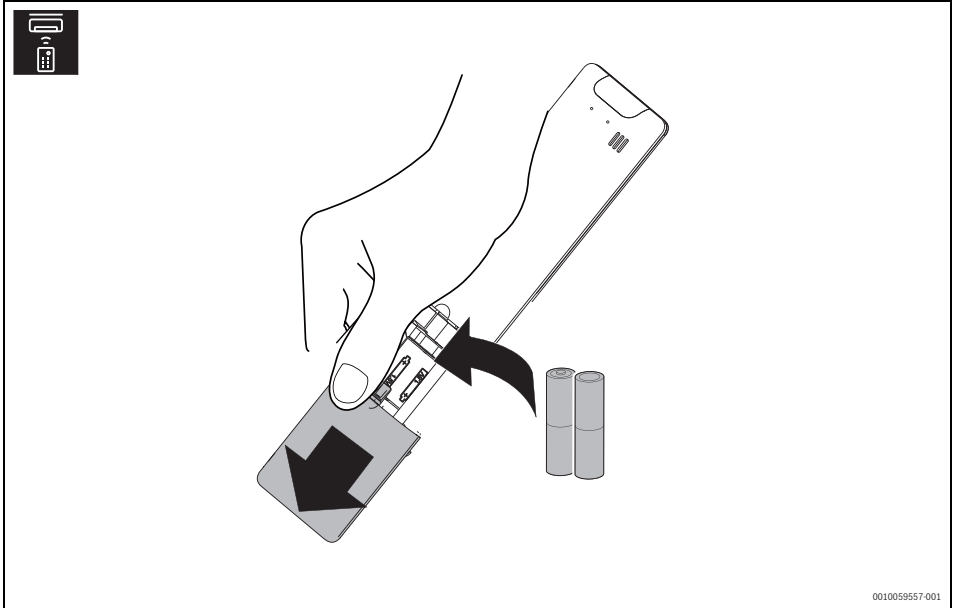

Obr. 125



Obr. 126







<https://docs.bosch-homecomfort.com/download/pdf/file/6721108249> 

Kot del naših pobud za zaščito okolja zagotavljamo spletne priročnike, do katerih lahko dostopate preko svojega pametnega telefona ali naša spletne strani, da se zmanjša uporaba priročnikov v papirnatih obliki.

0010059552-001

SI.127



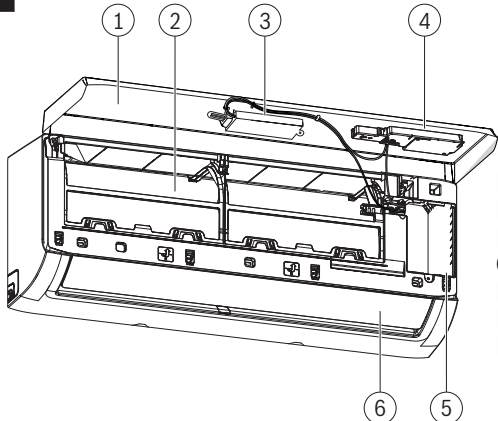

- [1] Zgornja plošča
- [2] Filter za zrak
- [3] Modul MC R (na voljo samo za modele CL6000iP...W F)
- [4] Zaslona
- [5] Gumb za ročni način delovanja
- [6] Plošča za pretok zraka

0010059553-001

SI.128

Številka
Prikaz temperature

WLAN
WLAN povezava je vzpostavljena

VKLOP
Prikazan z nekaterimi funkcijami, če so vklopljene. Prikazuje, da je časovnik vklopa vklopljen, ko je notranja enota izklopljena.

OF
Prikazan z nekaterimi funkcijami, če so izklopljene.

dF
Samodejno odtajevanje vklopljeno

Ex, Px, Fx
Koda napake (»x« pomeni katerokoli številko)

FP
Protizmrzovalna zaščita vklopljena: notranja enota ohranja sobno temperaturo vsaj 8 °C

CL
Funkcija samodejnega čiščenja je vklopljena (iClean)

SI.129

Vklop/izklop

Nastavitev načina delovanja

Način varčevanja

Hitrost ventilatorja

Nihanje

Superionizator

Način turbo

Tihi način

Način spanje

Ok Meni za potrditev

Nastavitev časovnika

- ▶ **ON** Pritisčajte tipko ali , da nastavite želeni čas
- ▶ **OFF** Pritisčajte tipko ali , da nastavite želeni čas
- ▶ Nastavite vrednost 0,0 ur

Zvišanje/znižanje temperature

Ključavnica za otroke + 5 s

0010059555-001

SI.130

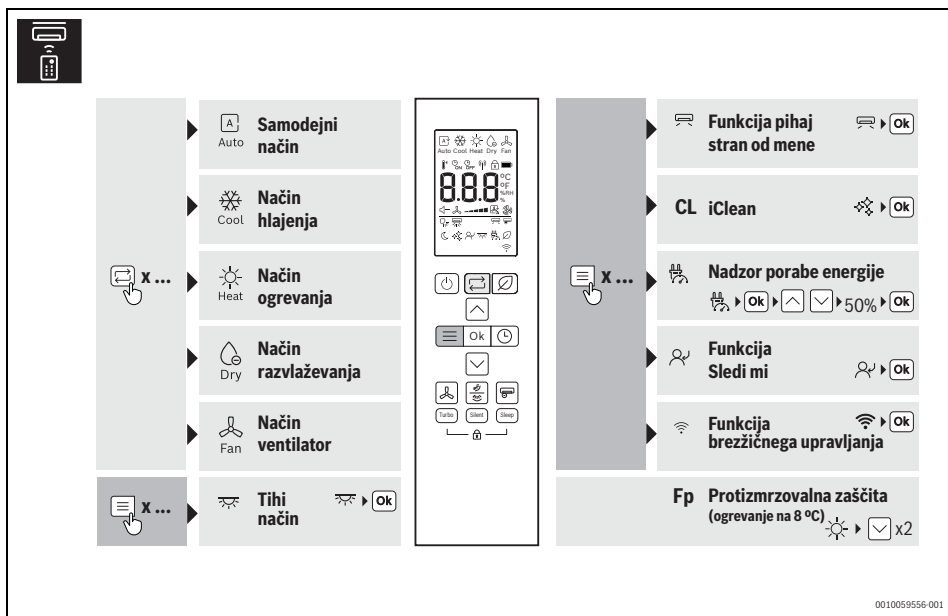

SI.131

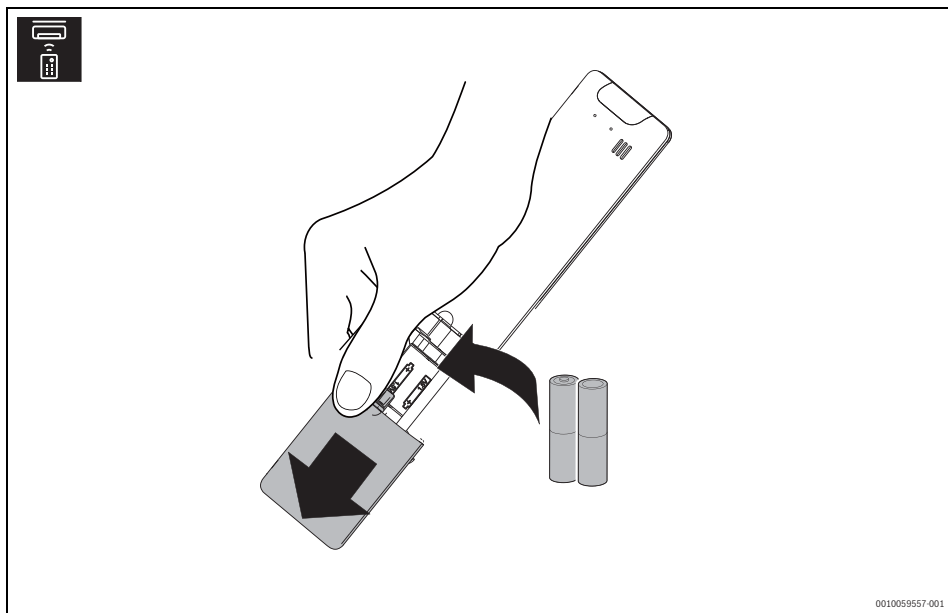

SI.132

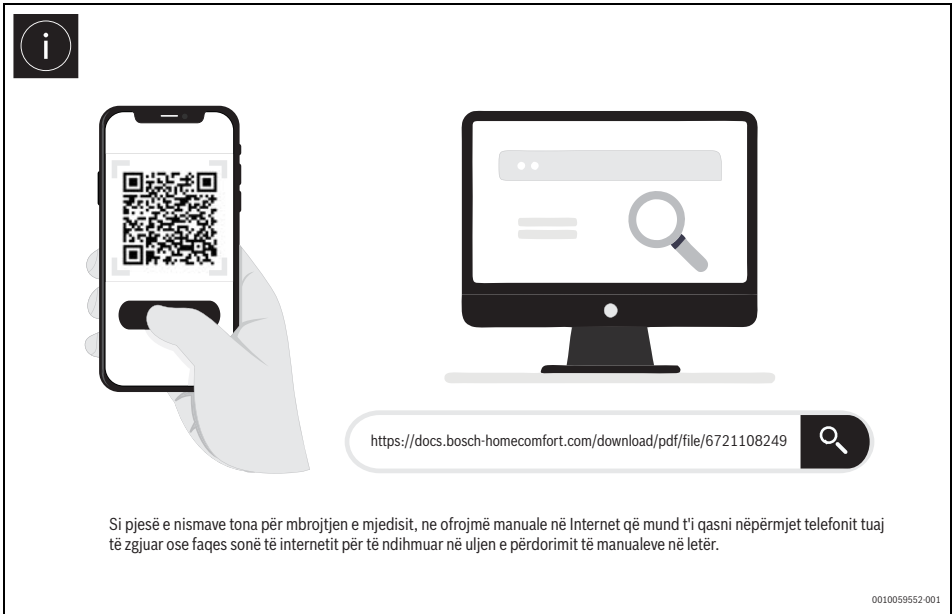

fig. 133

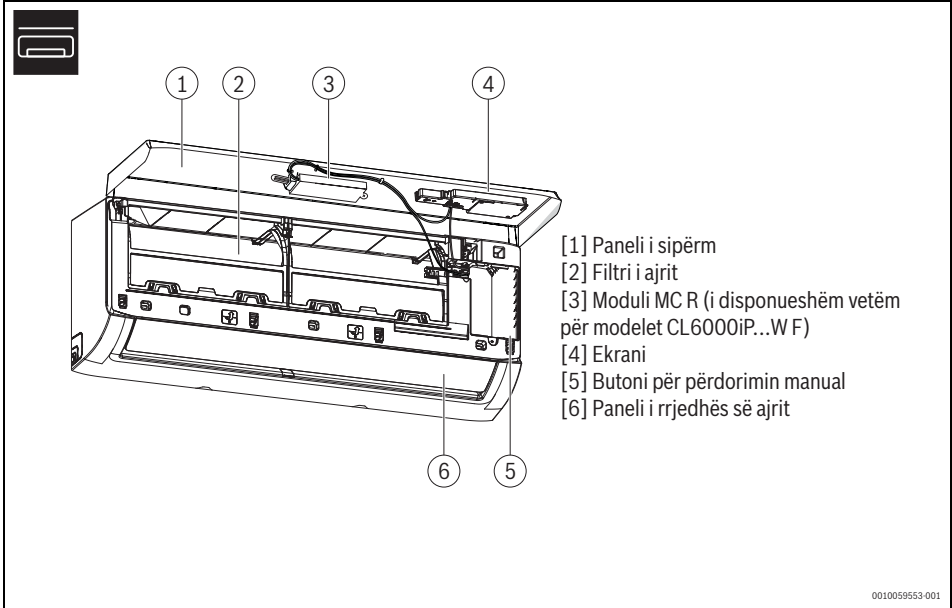
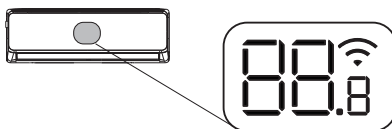

fig. 134



<p>NDEZUR</p> <p>Shfaqet me disa funksione, nëse këto janë aktivizuar. Tregon që kohëmatësi i ndezjes është aktiv kur njësia e brendshme është e fikur.</p>	<p>Numri</p> <p>Treguesi i temperaturës</p>	<p></p> <p>Lidhja WLAN aktive</p>
<p>Ex, Px, Fx</p> <p>Kodi i defektit ("x" qëndron për çdo shifër)</p>	<p>OF</p> <p>Shfaqet me disa funksione, nëse këto janë çaktivizuar.</p>	<p>dF</p> <p>Shkrija automatike është aktive</p>
<p>FP</p> <p>Mbrojtja nga ngrica është aktive: njësia e brendshme e mban temperaturën e dhomës të paktën 8°C</p>	<p>CL</p> <p>Funksioni i vetëpastrimit është aktiv (iClean)</p>	

fig. 135







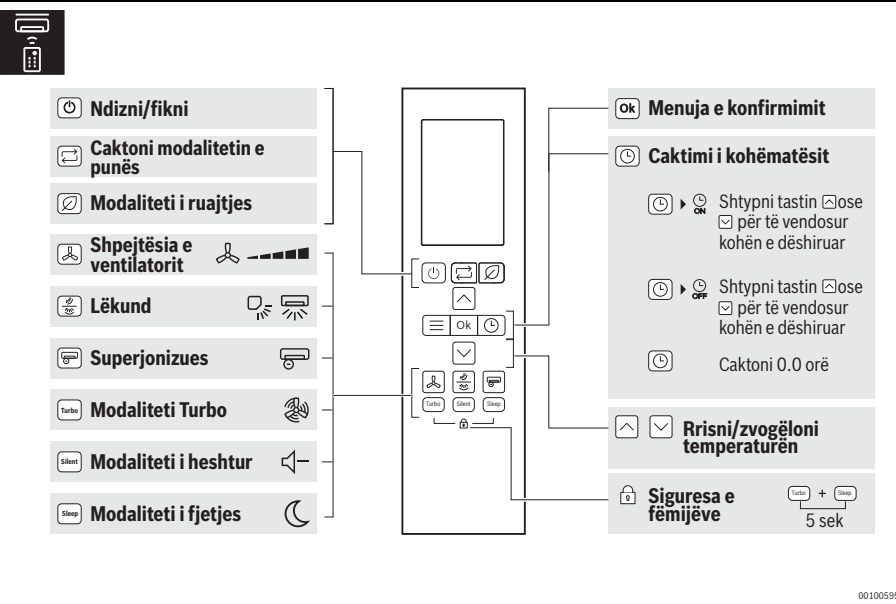













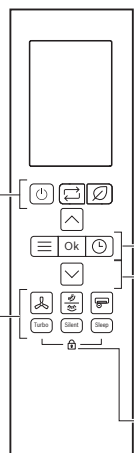



<ul style="list-style-type: none">  Ndizni/fikni  Caktoni modalitetin e punës  Modaliteti i ruajtjes  Shpejtësia e ventilatorit  Lëkund  Superjonizues  Modaliteti Turbo  Modaliteti i heshtur  Modaliteti i fjetjes 		<ul style="list-style-type: none"> Ok/ Menuja e konfirmimit  Caktimi i kohëmatësit <ul style="list-style-type: none">  ▶  Shtypni tastin  ose <input checked="" type="checkbox"/> për të vendosur kohën e dëshiruar  ▶  Shtypni tastin  ose <input checked="" type="checkbox"/> për të vendosur kohën e dëshiruar  Caktoni 0.0 orë   Rrisni/zvogëloni temperaturën  Siguresa e fëmijëve  +  5 sek
--	--	--

fig. 136

0010059555-001

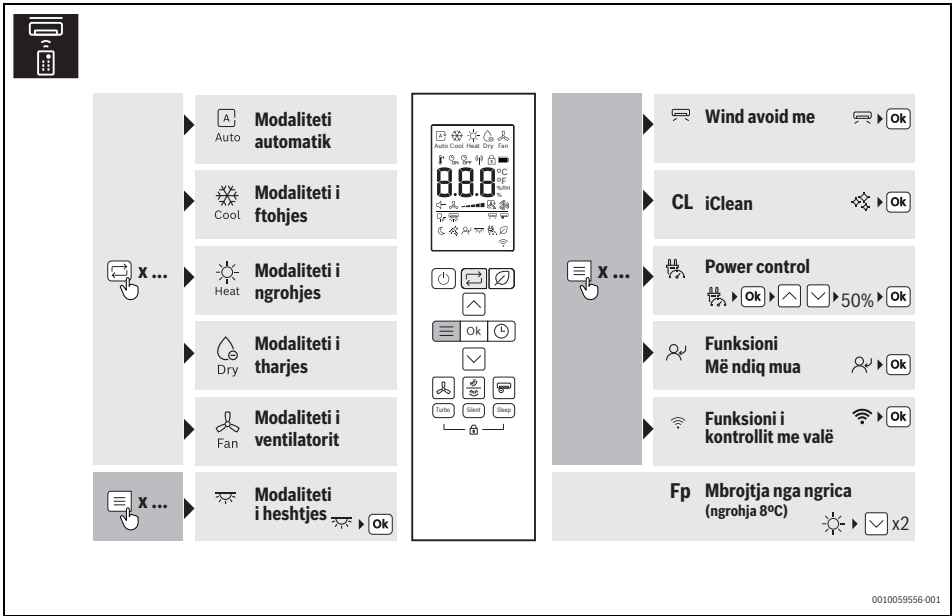

0010059556-001

fig. 137

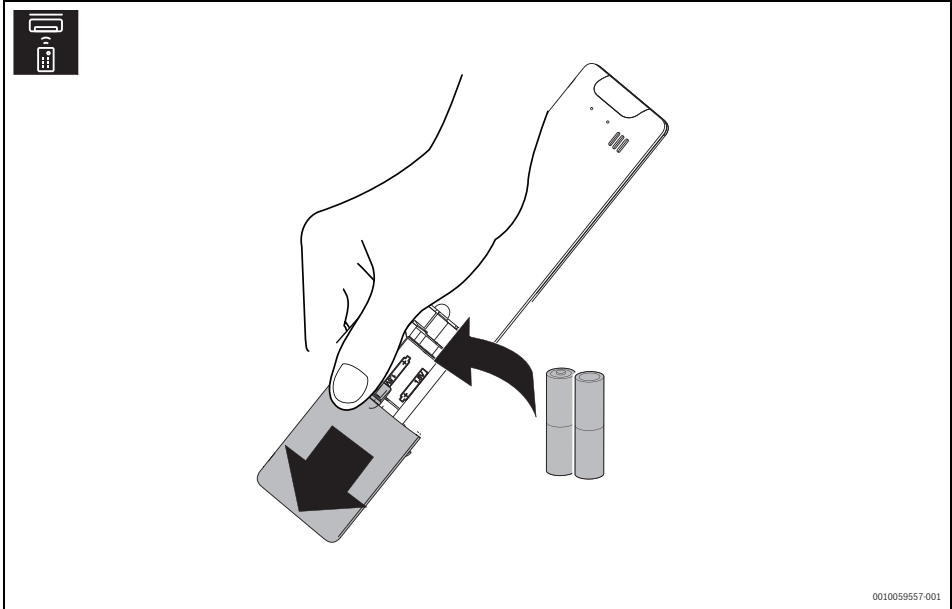

0010059557-001

fig. 138



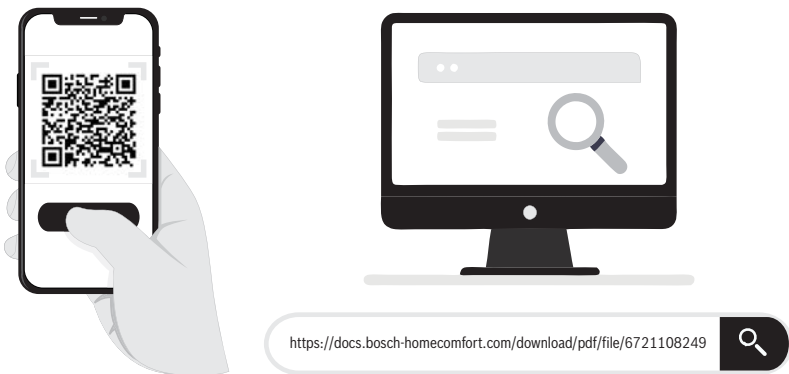

<https://docs.bosch-homecomfort.com/download/pdf/file/6721108249>

U okviru naših inicijativa zaštite životne sredine, obezbeđujemo onlajn priručnike kojima možete pristupiti preko pametnih telefona ili našeg veb-sajta čime se smanjuje upotreba papirnih priručnika.

0010059552-001

sl. 139



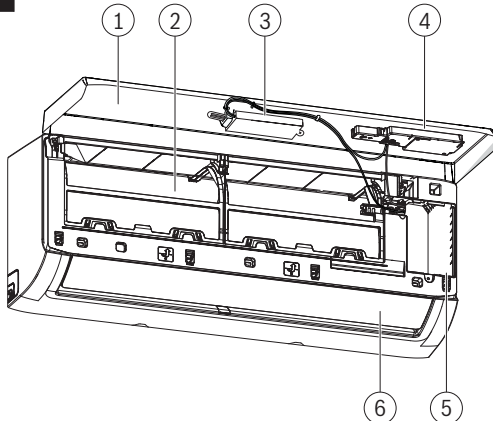

[1] Gornja ploča
[2] Filter za vazduh
[3] MC R modul (dostupan samo za modele CL6000iP...W F)
[4] Displej
[5] Taster za ručni režim rada
[6] Ploča strujanja vazduha

0010059553-001

sl. 140

<p>UKLJUČENO</p> <p>Prikazuje se uz neke funkcije, ako su one uključene. Pokazuje da je tajmer za uključivanje aktivan kada je unutrašnja jedinica isključena.</p>	<p>Broj</p> <p>Displej za temperaturu</p>	<p></p> <p>WLAN veza aktivna</p>
<p>Ex, Px, Fx</p> <p>Šifra greške ("x" označava bilo koju cifru)</p>	<p>OF</p> <p>Prikazuje se uz neke funkcije, ako su one isključene.</p>	<p>dF</p> <p>Automatsko odmrzavanje je aktivno</p>
<p>Ex, Px, Fx</p> <p>Šifra greške ("x" označava bilo koju cifru)</p>	<p>FP</p> <p>Zaštita od zamrzavanja je aktivna: unutrašnja jedinica održava sobnu temperaturu na najmanje 8 °C</p>	<p>CL</p> <p>Funkcija samostalnog čišćenja je aktivna (iClean)</p>

sl. 141

<p> Uključivanje/isključivanje</p>	<p> Meni za potvrđivanje</p>
<p> Podešavanje načina rada</p>	<p> Podešavanje tajmera</p>
<p> Režim čuvanja</p>	<p> Pritisnite taster ili da biste podesili željeno vreme</p>
<p> Brzina ventilatora</p>	<p> Pritisnite taster ili da biste podesili željeno vreme</p>
<p> Pomeranje</p>	<p> Podesite na 0,0 sati</p>
<p> Super jonizator</p>	<p> Povećanje/smanjivanje temperature</p>
<p> Turbo režim</p>	<p> Zaštita za decu 5 sekundi</p>
<p> Nečujan režim</p>	
<p> Režim spavanja</p>	

0010059555-001

sl. 142

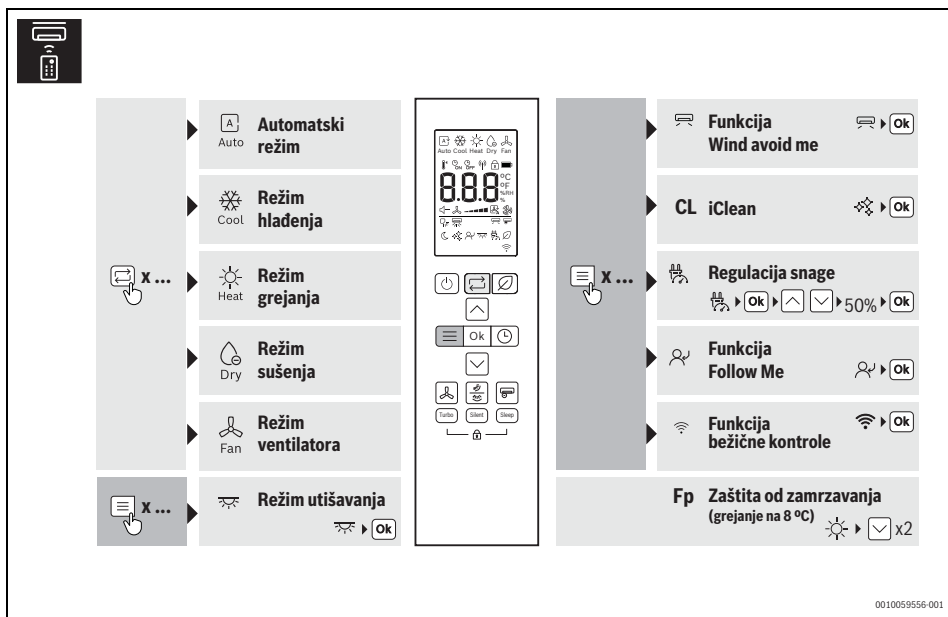

0010059556-001

sl. 143

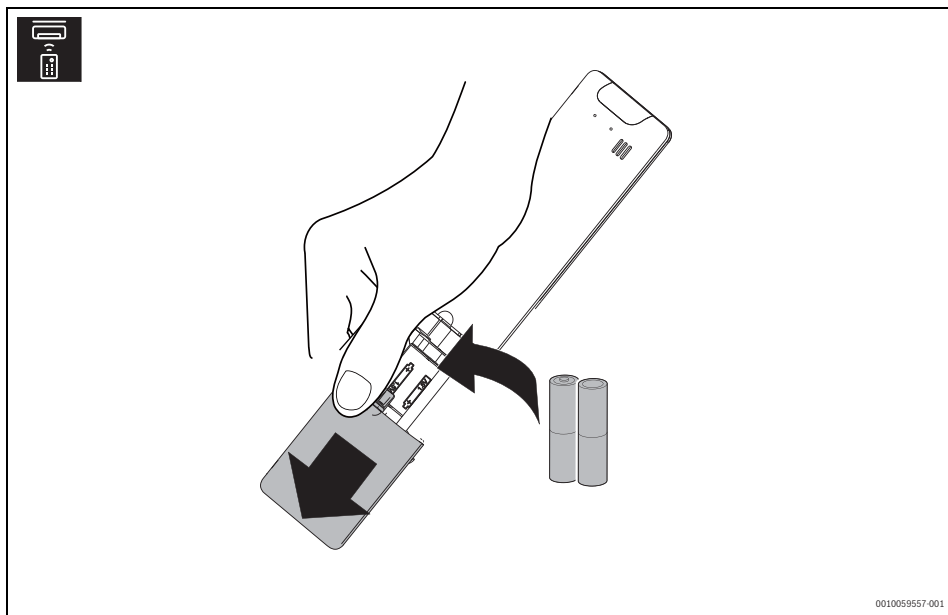

0010059557-001

sl. 144

i



<https://docs.bosch-homecomfort.com/download/pdf/file/6721108249>

Som en del av våra miljöskyddsinitiativ tillhandahåller vi online-handböcker som du kan läsa på din smarttelefon eller vår webbplats för att minska användningen av handböcker av papper.

0010059552-001

Bild 145



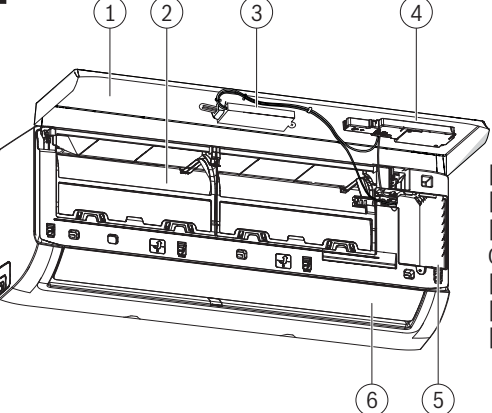

- [1] Frontlucka
- [2] Luftfilter
- [3] MC R-modul (endast tillgänglig för CL6000iP...WF-modeller)
- [4] Display
- [5] Knapp för manuell drift
- [6] Luftriktare

0010059553-001

Bild 146



Bild 147



0010059555-001

Bild 148

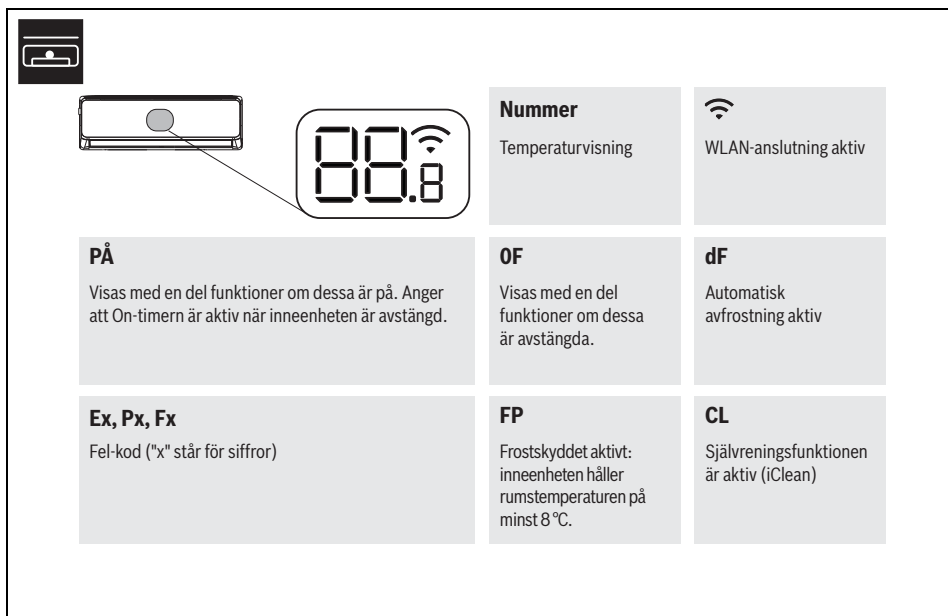
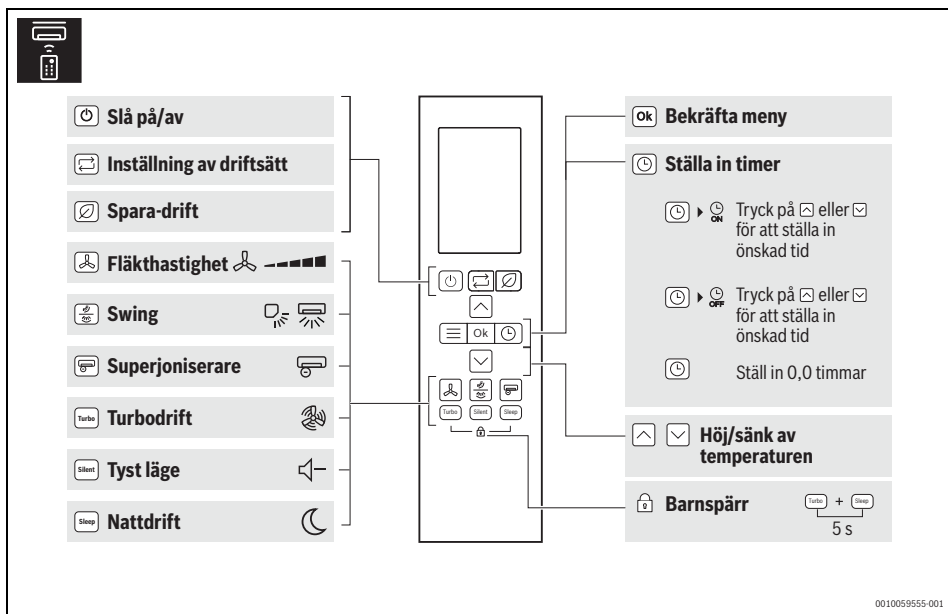
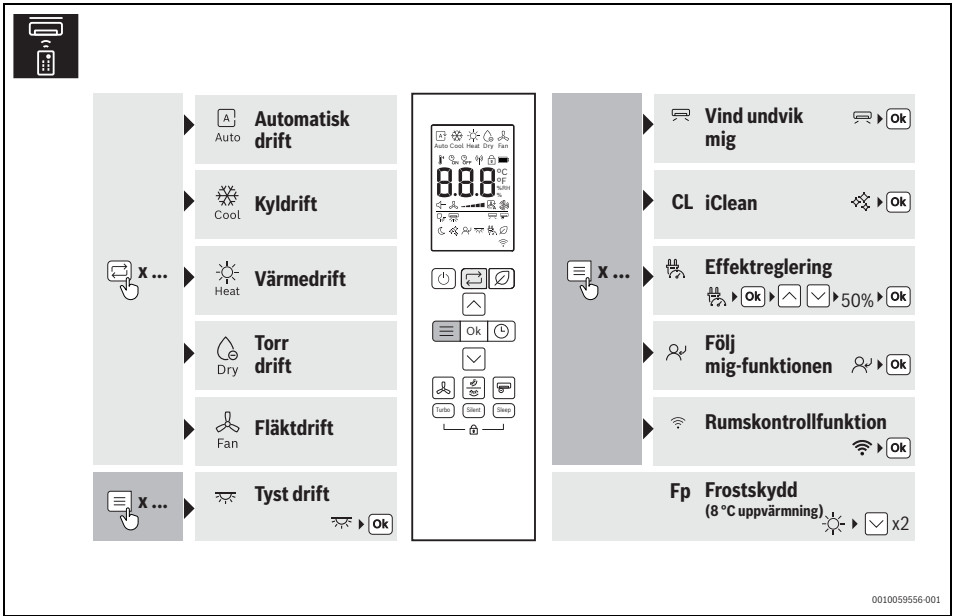

0010059556-001

Bild 149

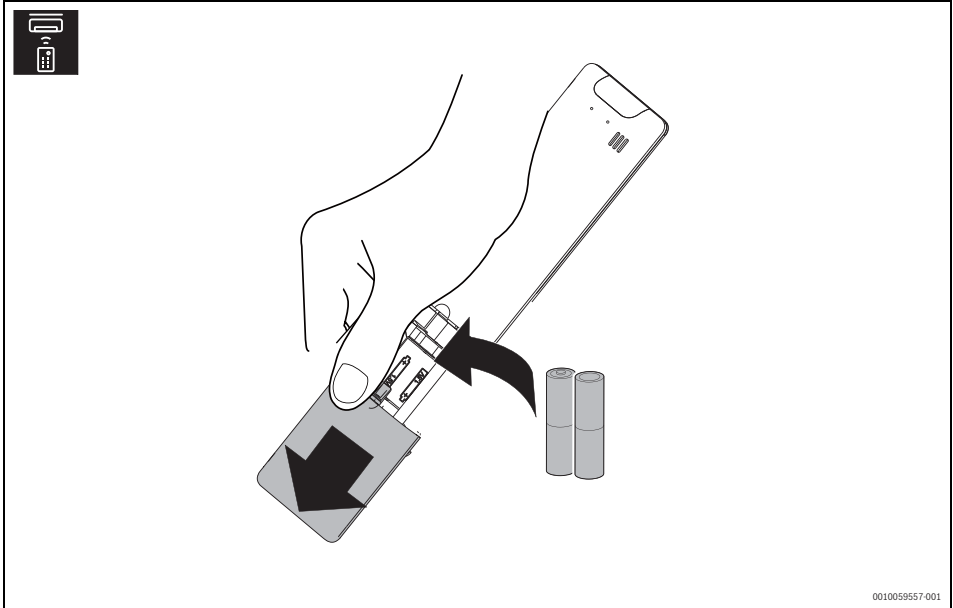

0010059557-001

Bild 150



Res. 151

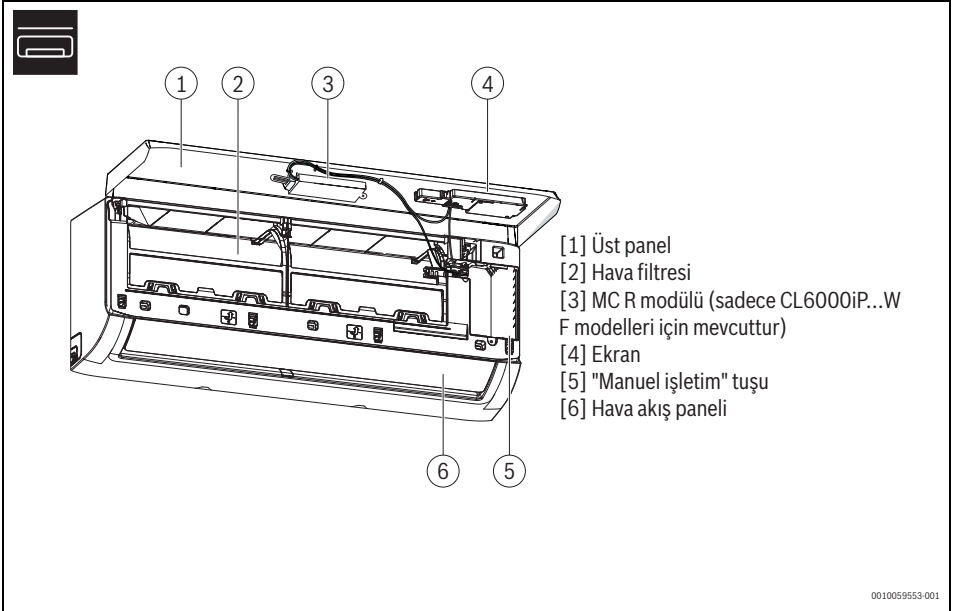



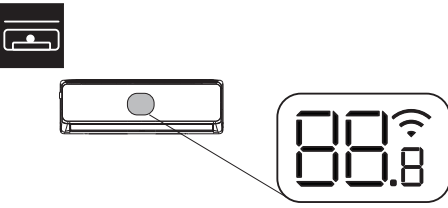





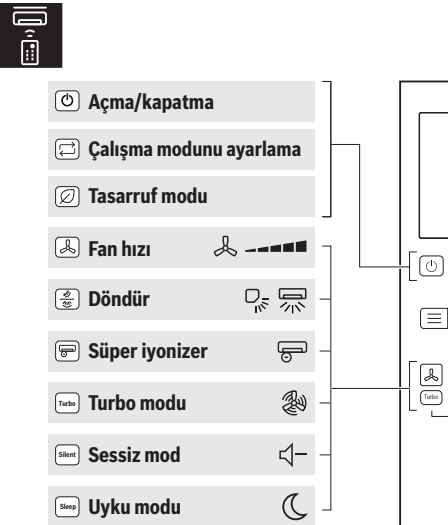



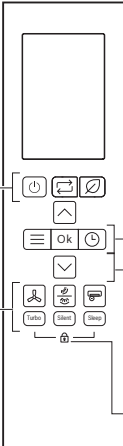















Res. 152



Adet Sıcaklık ekranı	 WLAN bağlantısı etkin
açık Bazı özellikler açıldıysa gösterilir. İç ünite kapatıldığında Açma program saatinin etkin olduğunu gösterir.	OF Bazı özellikler kapatıldıysa gösterilir.
Ex, Px, Fx Arıza kodu ("x" basamak anlamındadır)	FP Donma koruması etkin: İç ünite oda sıcaklığını en az 8°C seviyesinde tutar
	CL Kendi kendini temizleme işlevi etkin (iClean)

Res. 153



 Açma/kapatma		Ok Onaylama menüsü
 Çalışma modunu ayarlama		 Program saati ayarı
 Tasarruf modu		 ▶  İstenen saati ayarlamak için ☑ veya ☑ tuşuna basın
 Fan hızı 		 ▶  İstenen saati ayarlamak için ☑ veya ☑ tuşuna basın
 Döndür 		 0.0 saat ayarlayın
 Süper iyonizer 		  Sıcaklığı artırma/azaltma
 Turbo modu 		 Çocuk kilidi  +  5 sn
 Sessiz mod 		
 Uyku modu 		

0010059555-001

Res. 154

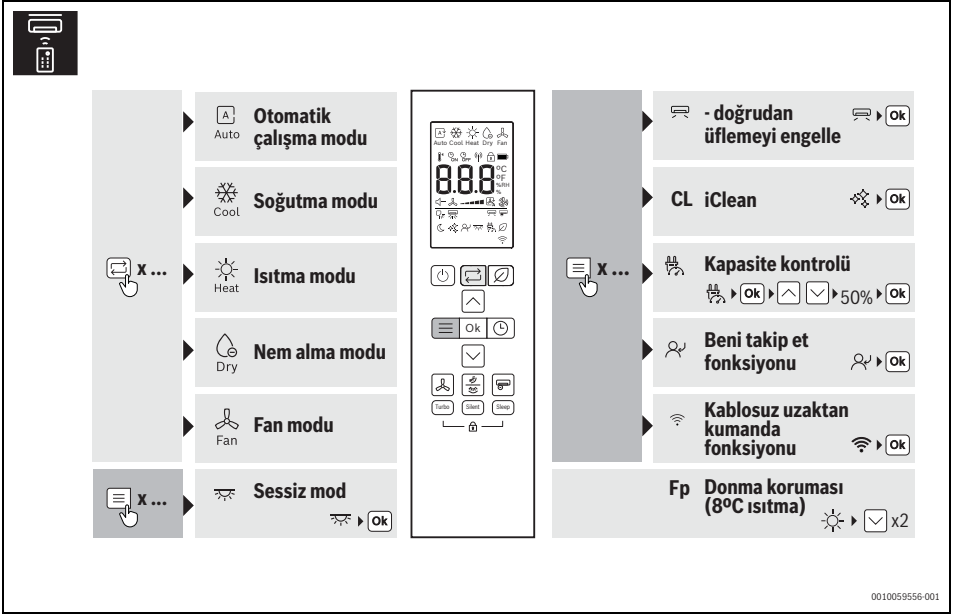

Res. 155

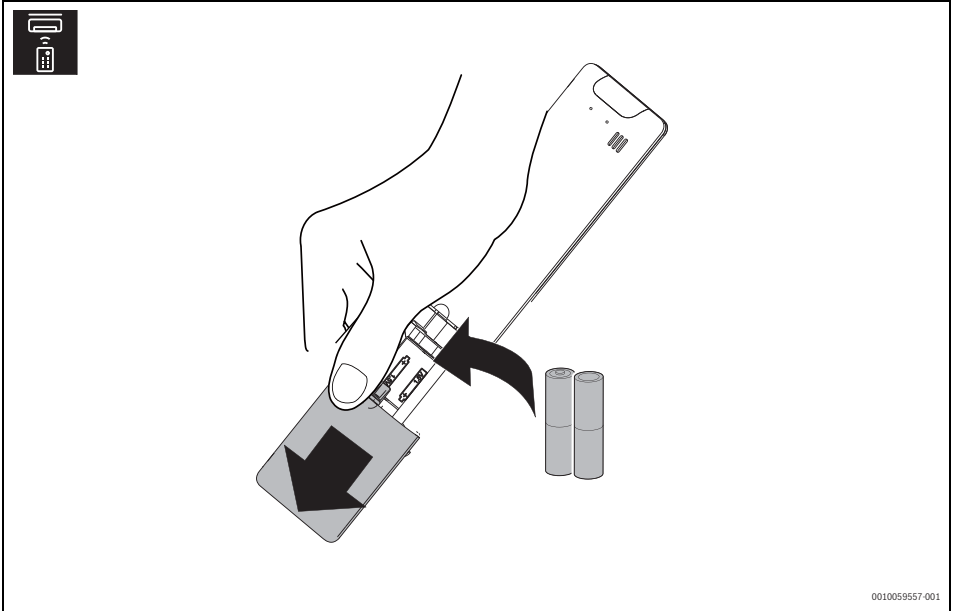

Res. 156

Garanti bilgileri

Ürün garanti belgesine QR kodu okutarak ve ilgili ürün kategorisini seçerek ulaşabilirsiniz. Basılı kopya talebiniz halinde lütfen satıcıya başvurunuz.



www.bosch-homecomfort.com/tr/tr/residential/servis-hizmetlerimiz/garanti/





<https://docs.bosch-homecomfort.com/download/pdf/file/6721108249>

Для сприяння зменшенню використання паперових посібників в рамках наших ініціатив щодо захисту довкілля ми надаємо онлайн-посібники, які можна завантажити за допомогою смартфона або на нашому вебсайті.

0010059552-001

Мал. 157

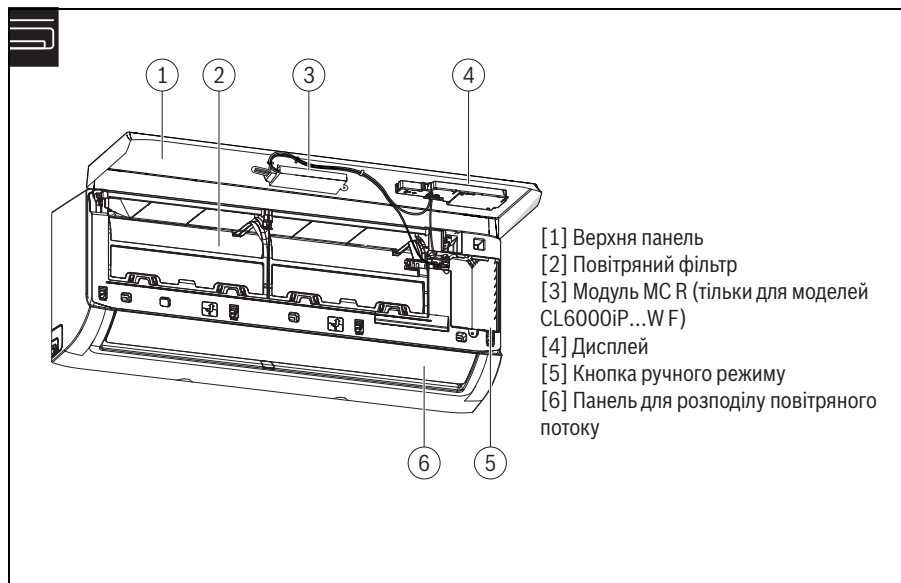

Мал. 158

<p>УВІМК</p> <p>Відображається разом з деякими функціями, якщо вони активовані. Вказує на те, що таймер активний, коли внутрішній блок вимкнено.</p>	<p>Номер п/п</p> <p>Відображення температури</p>	<p></p> <p>З'єднання WLAN активне</p>
<p>Ex, Pх, Fх</p> <p>Код несправності ("х" означає будь-яку цифру)</p>	<p>OF</p> <p>Відображається разом з деякими функціями, якщо вони вимкнені.</p>	<p>dF</p> <p>Автоматичне відтавання активовано</p>
	<p>FP</p> <p>Захист від замерзання активовано: внутрішній блок підтримує в приміщенні температуру щонайменше 8 °C</p>	<p>CL</p> <p>Функція самоочищення активна ("iClean")</p>

Мал. 159

<ul style="list-style-type: none"> Перемикач увімкнення/вимкнення Встановлення режиму роботи Режим енергозбереження Частота обертання вентилятора Поворот Першокласний іонізатор Режим "Турбо" Малозумний режим роботи Нічний режим роботи 		<ul style="list-style-type: none"> Підтвердження меню Налаштування таймера <ul style="list-style-type: none"> За допомогою кнопок або налаштувати потрібний час За допомогою кнопок або налаштувати потрібний час Встановити значення: 0,0 годин Збільшення/зменшення температури Захист від дітей + 5 сек.
---	--	--

Мал. 160

0010059555-001

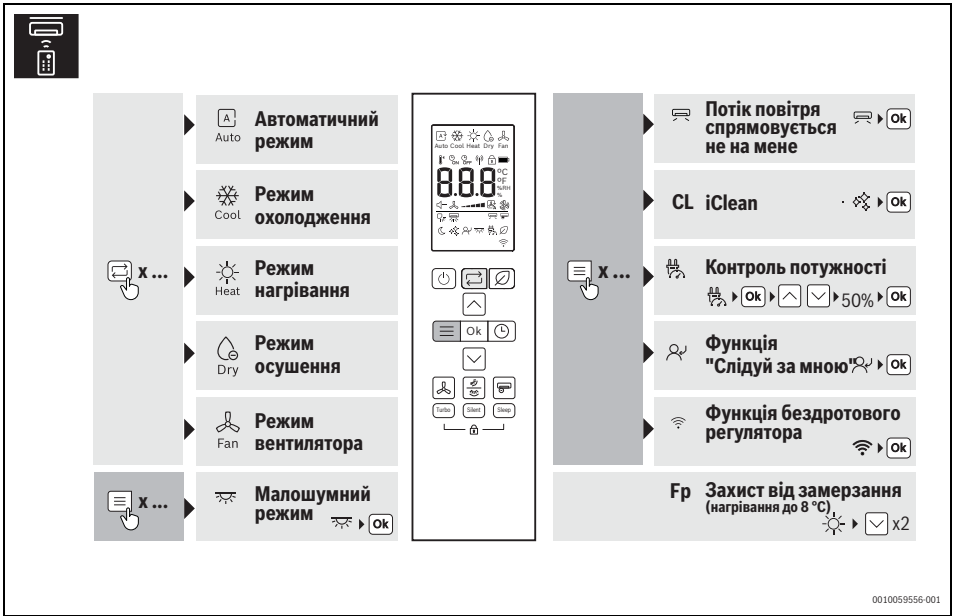

0010059556-001

Мал. 161

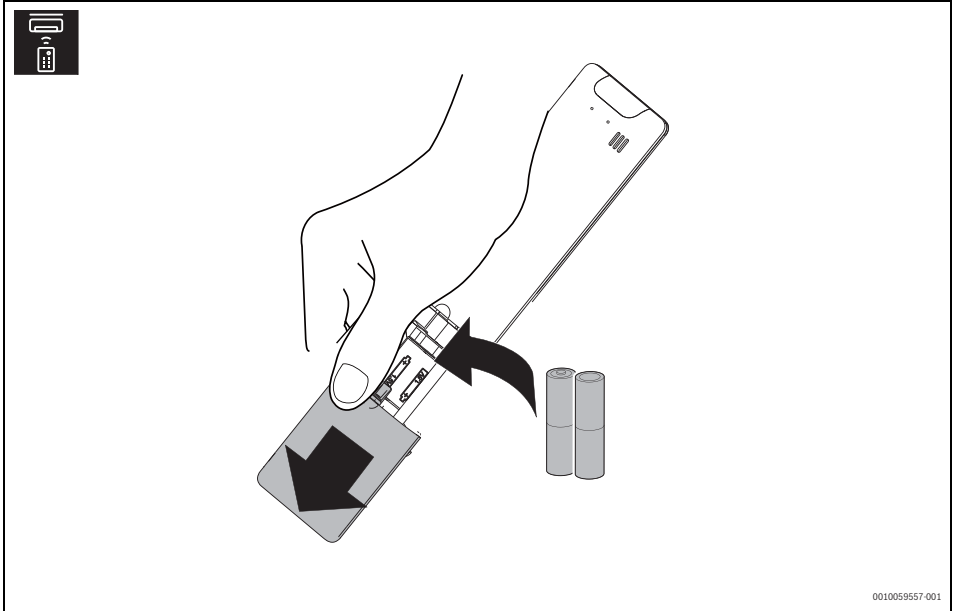

0010059557-001

Мал. 162

Bosch Thermotechnik GmbH
Junkersstrasse 20-24
73249 Wernau, Germany

www.bosch-homecomfortgroup.com

